

Installation Guide



Hardie® Panel &
Hardie® Architectural Panel
facade cladding



JamesHardie™



Content

01	Facade solutions with Hardie® Panel and Hardie® Architectural Panel	3	03	Installation of Hardie® Panel and Hardie® Architectural Panel	13
1.1	Product description Hardie® Panel & Hardie® Architectural Panel facade cladding	4	3.1	General	13
1.2	Rainscreen facade system	5	3.2	Timber subframes	14
1.3	Classification	6	3.2.1	Fastening to timber battens	17
1.4	Tools and Accessories	6	3.2.2	Technical specifications/details	20
02	Preparation of Hardie® Panel and Hardie® Architectural Panel	8	3.3	Aluminium subframes	27
2.1	Storage and Handling	8	3.3.1	Fastening to aluminium subframes with Hardie™ rivet	30
2.2	Cutting	11	3.3.2	Fastening to aluminium subframes with Hardie™ Panel screw	35
			3.3.3	Technical specifications/details	38
			3.4.	Cladding of soffits and fascia	45
			04	Follow-up	46
			4.1	Maintenance and servicing	46
			4.2	Final and regular cleaning	46



01 Facade solutions with Hardie® Panel and Hardie® Architectural Panel

Endless design possibilities

Affordable housing is the hot topic of the moment. Land prices are skyrocketing, and construction costs must compensate. The durability, low maintenance requirements, high weather resistance and our guarantee promise make Hardie® Panel & Hardie® Architectural Panel facade panels ideal products for cost-efficient and at the same time attractive facade design.

When it comes to strength, stability and modernity, this facade design is the optimal solution for you. James Hardie offers you cost-effective solutions with attractive design options. The large format and flexible colour schemes bring straightforwardness and modernity to your building projects. Whether you have a large or small scale project, Hardie® Panel & Hardie® Architectural Panel cladding can help you achieve the best possible results.

Durability

Thanks to our technological innovations, Hardie® products outperform other cladding products. Hardie® fibre cement is impact, fire, insect and weather resistant. Hardie® Panel & Hardie® Architectural Panel are designed to withstand European climates and weathering without sacrificing dimensional stability. The moisture resistance allows to maintain all product properties in its dry state, even when our fibre cement is exposed to moisture and humidity.

The formulation

Hardie® Panel consists of cement reinforced with cellulose fibres, sand and water. Added to this is a small number of additives that give Hardie® products their unique, long-lasting properties.

1.1 Product description Hardie® Panel & Hardie® Architectural Panel facade cladding

Purposely designed as external cladding for commercial buildings in both new build and renovation. Hardie® Panel and Hardie® Architectural Panel can be used as part of a rainscreen cladding system fixed to either timber frame, metal frame or masonry walls using corrosion resistant fixings. Our cladding can be installed with or without insulation.

Textures and colours

Hardie® Panel is available in a lightly textured finish. For individual and modern facades, Hardie® Architectural Panel is available in various textured surfaces.

Hardie® Architectural Panel Metallics combines the look of a fibre cement facade cladding with a special metallic look that comes in 6 metallic colours.

A 15-year guarantee testifies our confidence in the durable and low-maintenance surface and panel. The texture of the facade panel is particularly visible under incident sunlight. Differences in structure or gloss level have no effect on the general product properties and give the facade a natural, lively appearance.

The products are available in modern standard colours. We offer a custom colouring service in almost any colour to meet your specific project requirements.

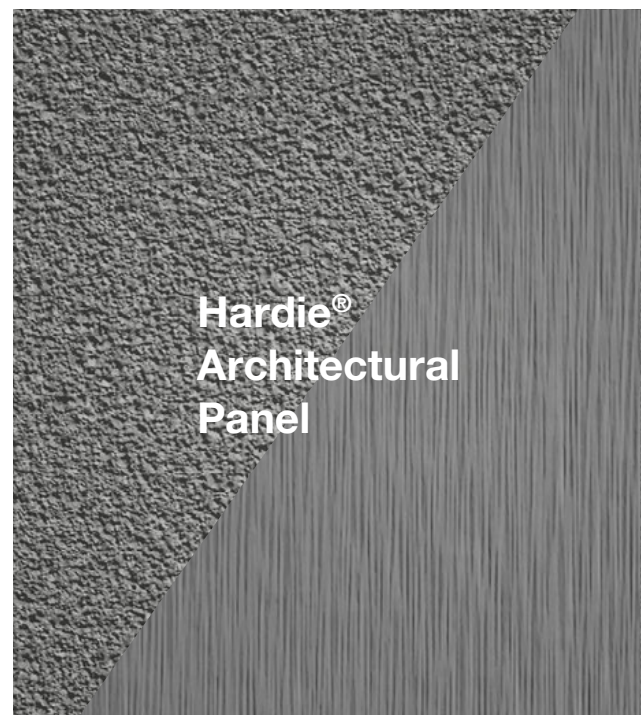

1.2 Rainscreen facade system

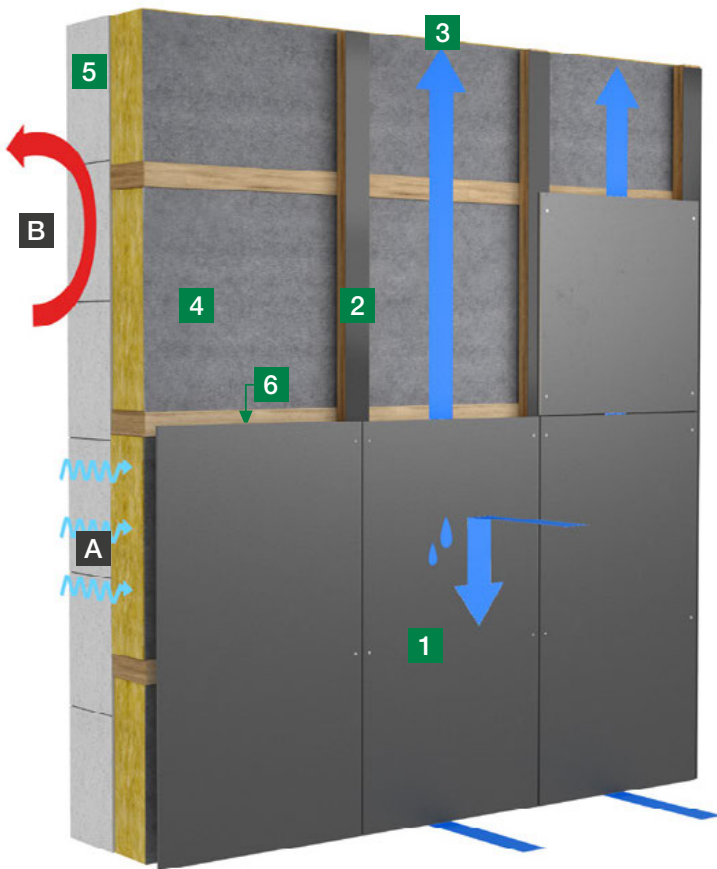

- 1 Hardie® Panel or Hardie® Architectural Panel
- 2 subframe
- 3 ventilation area
- 4 insulation (optional)
- 5 structural wall
- 6 Hardie® Shield (optional)
- A Diffusion
- B Heat Flow

Benefits

For use

- Low maintenance
- Non-combustible
- Energy efficiency

Installation

- Dry installation
- Easy and full year installation
- Easy deconstruction

Building physics

- Rapid drying
- Temperature control

Principle of rainscreen facade

Rainscreen facades allow the structural separation of the facade functions, insulation and weather protection. The cladding which is installed with a distance to the insulation ensures protection against wind and weather.

This ensures that, on the one hand, the insulation material is effectively protected from moisture, and on the other hand, moisture from the building that diffuses through the outer wall and insulation material is safely removed via the air layer behind the outer cladding.

This separation of the facade components also ensures the ecological sustainability of the system: if the building is dismantled later, the individual components can be dismantled according to type and then recycled.

1.3 Classification

The quality properties of Hardie® Panel & Hardie® Architectural Panel are continuously monitored by the company itself and are also subject to constant quality control by material testing institutes (external monitoring).

Properties	Hardie® Panel Hardie® Architectural Panel Metallics		Hardie® Architectural Panel	
Thickness EN 12467	8 ± 0.8 mm	11 ± 1.1 mm	8 + 1.2/-0.8 mm	11 + 1.65/-1,1 mm
Category and Class (EN 12467)	Category A, Class 2			
Fire Classification (EN 13501-1)	A2-s1, d0			
Length*	Raw: 3048 ± 5 mm / Net.: 3038 mm			
Width*	Raw: 1220 ± 3.66 mm / Net.: 1210 mm			
Nominal Squareness (DIN EN 12467)	Level I			
Gross Density	~ 1300 kg/m ³			
Mass per unit area	11.2 kg/m ²	13.7 kg/m ²	11.2 kg/m ²	13.7 kg/m ²
Thermal Conductivity	$\lambda_{10, tr} = 0.23 \text{ W/mK}$			
Thermal Resistance	$R_{10, tr} = 0.035 \text{ m}^2\text{K/W}$	$R_{10, tr} = 0.048 \text{ m}^2\text{K/W}$	$R_{10, tr} = 0.035 \text{ m}^2\text{K/W}$	$R_{10, tr} = 0.048 \text{ m}^2\text{K/W}$
Flexural Strength (EN 12467)	15,5 MPa perpendicular to fibre direction 10,1 MPa parallel to fibre direction	18,0 MPa perpendicular to fibre direction 12,5 MPa parallel to fibre direction	14,0 MPa perpendicular to fibre direction 8,5 MPa parallel to fibre direction	17,0 MPa perpendicular to fibre direction 11,8 MPa parallel to fibre direction
Young's modulus	6200 N/mm ²		5100 N/mm ²	
Linear strain, 30–90 % relative humidity	≤ 0.05 mm/m**			
Impact Resistance (soft and hard impact as per EAD 090062-00-0404)***	–	Category 1 (H1-3, S1-4)	–	Category 1 (H1-3, S1-4)

* trimming of 5mm per side from the raw size is recommended for optimal squareness

** between 30 % and 90 % rel. humidity

*** on timber aluminum steel and NV3

Start your planning with the
James Hardie sample packs

Order your Hardie® Panel sample now:
www.jameshardie.eu/panel-sample-request



1.4 Tools and Accessories

Hardie™ Seal Edge Sealer



An acrylic coating, available in matching colours, required to seal the cut ends of the facade cladding. Available in 0.5 litre cans.

Hardie™ Panel Screws (for wood frame)



A2 stainless steel screws for fastening Hardie® Panel & Hardie® Architectural Panel siding to wood framing. The screw heads are matched to the colour scheme of the Hardie® Panel & Hardie® Architectural Panel fibre cement panels.

Hardie™ Panel Screws (for aluminium frames)



A2 stainless steel screws for fastening Hardie® Panel cladding to aluminium subframes. Size: 5.5 × 25 mm D12 (8 mm).

Hardie™ Panel Rivet (for aluminium subframes)



Aluminium rivet (AlMg₃) with rivet mandrel made of stainless steel for fastening Hardie® Panel cladding to aluminium subframes. Size: 5,0 × 16 mm D14

Hardie™ Fixed point sleeve



Aluminium fixed point sleeve in 9,4 × 6 mm for centric insertion of the fixings.

Hardie™ Centralising Tool



Used on pre-drilled panel to ensure a concentric hole is drilled in the metal subframe behind the panel.

Ventilation profile for Hardie® Panel



Ventilation profile, for ideal ventilation and protection against rodents. Available in three leg depths: 25 mm, 38 mm and 50 mm, length: 3000 mm.

Hardie™ Panel MetalTrim™ Trim

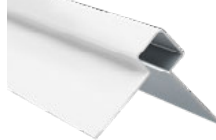

High-quality, powder-coated aluminium profiles for modern exterior corner design. Available in 6 standard colours and custom colour. Length: 3000 mm.

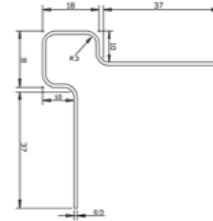

Hardie™ EPDM tape



UV-resistant EPDM joint tape for protection against permanent moisture penetration of the wooden subframes. Available in lengths of 20 m and in widths of 60, 80, 100 and 120 mm. Thickness 0.7 mm Length 20 m.

Hardie™ Saw Blade



Diamond-tipped saw blade. Available in 160 mm (suitable for 20/16 mm diameter holes), 190 mm (suitable for 30/20 mm diameter holes), 254 mm and 305 mm (suitable for 30 mm diameter holes), 254 mm and 305 mm (suitable for 30 mm diameter holes).

For outdoor use only.

The saw blade is designed to minimise dust formation.

Thanks to diamond trimming, it achieves a long service life with sustained precise cutting.

Hardie™ Blade blades fit most corded or cordless circular saws.

Warranty

15-year warranty on Hardie® Panel and Hardie® Architectural Panel and surface coating according to the warranty terms when properly applied as per the installation instructions.

15 Year Warranty

02 Preparation of Hardie® Panel and Hardie® Architectural Panel

2.1 Storage and Handling

Storage



Hardie® Panel and Hardie® Architectural Panel must be stored covered, level, and dry.

Pallets must be protected against rising damp and weathering. Damp products must not be installed, or damage may occur. The cover of the pallets can be reused for dry storage.



A maximum of 5 pallets (with 25 panels each) may be stacked on top of each other. Make sure that the storage woods of the pallets are vertically on top of each other.



If the panels are not assembled immediately after delivery to the construction site, they should be stored in a protected area.

Handling

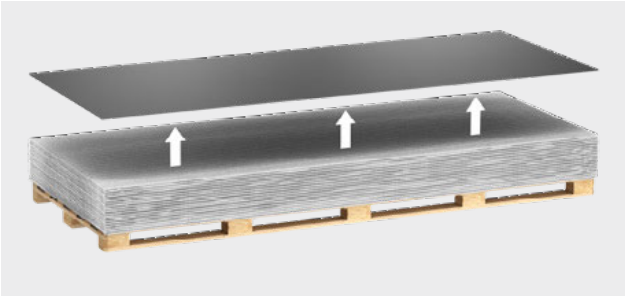

The panels should be lifted straight and not pulled over each other to avoid damage to the surface.



To lift, the panel should be erected over the narrow edge and then carried landscape by two installers.

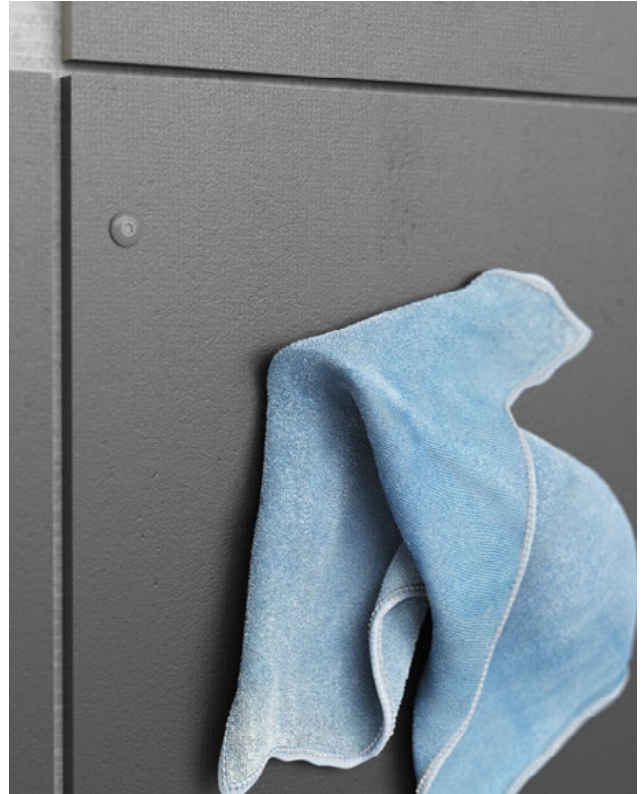

Dust should be removed immediately with a soft cloth such as a microfiber or soft brush.



Avoid the contact with grease/oil & silicone, as these can leave permanent stains. For safety reasons the use of clean gloves is advisable while avoiding staining the panels.

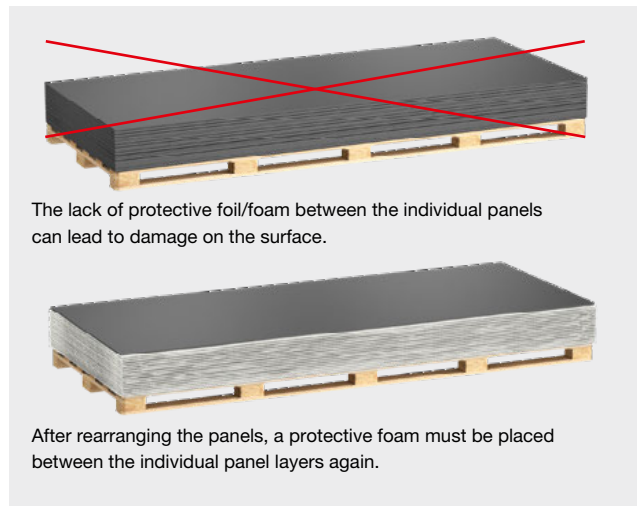

The lack of protective foil/foam between the individual panels can lead to damage on the surface.

After rearranging the panels, a protective foam must be placed between the individual panel layers again.

Hardie® Panel & Hardie® Architectural Panel facade panels are covered with a protective foil to protect the surface during shipping. When repositioning the panels, make sure the foil is placed back between the panel layers to prevent surface damage.

Use mechanical lifting equipment if possible. Ensure that the vacuum is set correctly to avoid damage to the surface.

Dimensions

The nominal production dimensions of the panel is 3048 × 1220 mm.

Edge trimming

Although Hardie panels provide mechanical consistency during the production. Trimming 5 mm on the edges is advisable for optimum squareness of the final installed panels.

Trimmed edges should be chamfered with sandpaper (e.g. 120 grit).



All trimmed/cut edges must be sealed with Hardie™ Seal edge sealer. The edge sealant protects the panel from moisture absorption. It is available in all standard colours and custom colour to match the surface.

Before applying the edge sealer, make sure that the edges are clean, dry, and dust-free.

The temperature must be between +5° C and +35° C.

Furthermore, please observe the information given in the product data sheet of the Hardie™ Seal edge sealant.



A paint applicator with a small sponge, if available with a triangular tip, or a fine paint roller is suitable for application, as this is the best way to work in a controlled manner.

Do not apply the paint over a large area on the front of the facade panels. Wipe off excess paint immediately from the factory coated surface.

You can also use Hardie™ Seal edge sealer to touch up small scratches or dents no larger than 6 mm. Please use only in small amounts and only on the affected area, as the paint may settle from the panel surface. If the damage is still visible, please replace the facade panel.

2.2 Cutting

Tools

The use of Hardie™ Blade saw blades is recommended for great clean cuts and low dust emission. Furthermore, other commercially available polycrystalline diamond saw blades are also suitable for cutting Hardie® fibre cement panels.

The optimum cutting speed for industrial saws should be 40–50 m/s. In general, higher cutting speeds allow for better cutting-edge quality.

Overview Hardie™ Blade

diameter	Ø160 mm	Ø190 mm	Ø254 mm	Ø305 mm
Cutting width	4 mm	4 mm	4 mm	4 mm
hole size	20 mm	30 mm	30 mm	30 mm
rotation/minute	4 800	4 000	3 000	2 800



Lower cutting speeds should be used for hand-held circular saws.

When cutting Hardie® Panel & Hardie® Architectural Panel, please consider the following:

- Please always use an EU-approved dust mask (fine dust mask of protection class 2 or 3).
- The panels must always be cut outdoors or indoors with appropriate dust extraction equipment.

The remaining dust must be removed immediately with a soft cloth such as a microfiber or soft brush. The use of a dust extractor while cutting is mandatory.

Cut-outs

Use a jigsaw or a hole saw equipped with carbide, bi-metal, or diamond tipped (e.g. Bosch saw blade type jigsaw blade T 141 HM or equivalent). Cut-outs should always take place before installation on the facade.

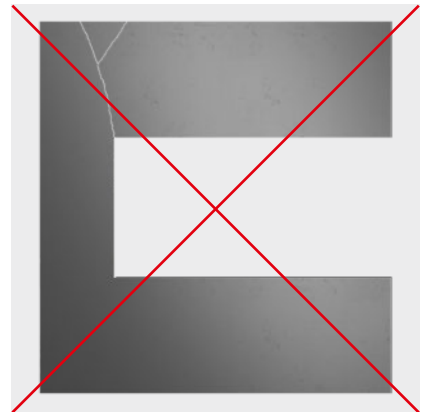
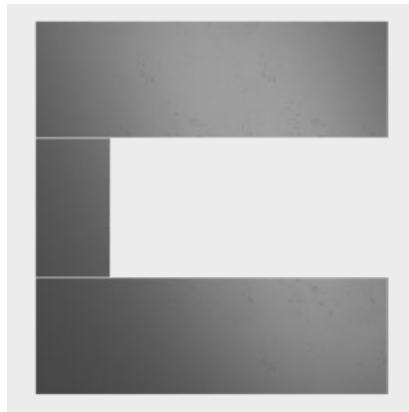

Correct mounting of Hardie® Panel & Hardie® Architectural Panel at windows, doors and openings.

Wrong mounting of Hardie® Panel & Hardie® Architectural Panel at windows, doors and openings.

To reduce the risk of breakage, when installing Hardie® Panel & Hardie® Architectural Panel around windows, doors, and other openings or notched panels, make sure the panels are installed according to the guidelines. James Hardie recommends cutting separate strips around the opening.

When calculating the cutting for the panel, consider the width of the joint (max. 10 mm). Vertical joints must be backed with a support profile or with a support batten. Narrow strips < 250mm should be avoided. Cut-to-size panel strips with a width of 250mm must be fastened with two rows of fasteners, observing the minimum corner and edge distances specified in this document.

Wall penetrations

For penetrations such as pipes or faucets, James Hardie recommends using diamond drill bits or carbide-tipped hole saws. Create a hole of at least 6 mm larger than the pipe diameter. The gap might be sealed with a hybrid polymer or acrylic sealant (never with silicone, due to staining over the panels).

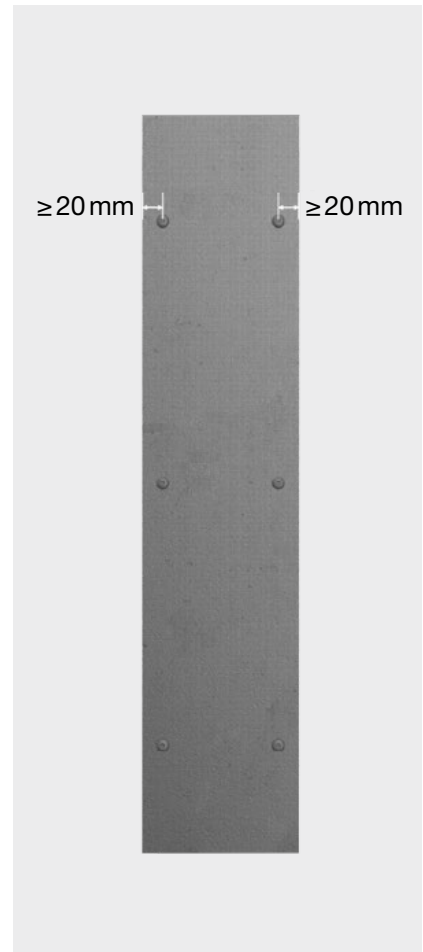

03 Installation of Hardie® Panel and Hardie® Architectural Panel

3.1 General

Construction

James Hardie does not specify the fastening distance requirement to the building and will not take the liability of such element calculations. The attachment of the framing should be incorporated into the overall building design and should be approved by the responsible parties.

Structure

The structural wall to which Hardie® Panel cladding is to be fixed, must be of sufficient strength and stiffness to satisfy the requirements of the local building regulations. The wall may be made of masonry, timber, or steel. In the case of the latter, a sheathing board must be installed over the frame/ behind the rainscreen facade.

Waterproof Membrane

The use of waterproof membranes is in compliance with regional codes in a rainscreen assembly.

Ventilation Cavity

A min. ventilation cavity of 20 mm is mandatory. Ventilation at bottom and top need to be kept. Horizontal framing should be avoided as this can block the ventilation.

Movement joints

The movement joints of the building must be taken over in the subframes as well as in the facade cladding.

Due to the small change in length of the panel material under the influence of moisture, no further movement joints need to be planned.

Rear ventilation cross-section / ventilation openings

In general, the trade regulations of the individual adjoining trades must always be observed.

Ventilation is provided via the base area of the facade. It must always be ensured that the air flow is guaranteed over the entire height of the facade.

The opening at the base also serves to discharge moisture (through diffusion, condensation, and weathering).

A ventilation opening must also be provided at the upper end of the facade.

A minimum distance of 10 mm or a minimum ventilation gap of 50 cm² (depending on country regulations) per running metre must be planned under windowsills. The ventilation gap is formed between the upper edge of the facade panel and the lower edge of the windowsill.

A ventilation opening must also be provided above windows and doors. A ventilation cross-section of at least 50 cm² per running metre is also required here. Diffusion moisture and condensation water can also be discharged through these openings.

No horizontal profiles may be installed above or below the window openings. These would prevent rear ventilation.

3.2 Timber subframes

General

The construction of a rainscreen facade on a subframe made of timber, consists of several levels according to the specifications of DIN 18516-1.

With special frame anchors, there is the option of anchoring the load-bearing batten directly in the wall substrate.

The dimensioning of the fastening, connection and anchoring in the substrate is carried out for a timber subframe according to the corresponding specifications of DIN EN 1995-1-1 (EC5) in conjunction with the national annex. Wooden battens with the minimum strength class C24 (S10) must be used for the subframes.

Hardie™ Panel screws for timber frames with dimensions 4.8×38 mm, head diameter 12 mm must be used for fastening to the supporting battens.

James Hardie Europe GmbH cannot accept any liability for the use of other screws.



Construction with horizontal counter battens



Support battens fixed to the substrate with frame anchors



Wooden subframe with spacers

Timber preservation

The use of non-chemical preserved timber is a significant contribution to environmental protection.

When using a timber subframe, the following must be observed: The use of technically dried timber with installation moisture contents of $\leq 20\%$, under roof or cover, meets the requirements for modern structural measures according to DIN 68800-2 to avoid damage by fungi and insects. This corresponds to service class GK 0 according to DIN 68800-2. In this case, counter-battens and supporting battens do not need to be treated chemically to prevent fungal or insect attack.

GK 0 is given if the wood moisture content at the time of installation is $< 20\%$ or if it is ensured that this wood moisture content is reached by drying no later than six months after installation.

Furthermore, suitable measures must be taken to ensure that the wood moisture content does not permanently exceed 20% in the state of use.

This includes measures to protect against usage moisture, e.g. splash water, moisture from adjacent building components or condensation or water entering through the panel joints.

To prevent moisture damage to the timber subframes caused by water entering from the outside, an Hardie™ EPDM tape must be applied between the facade panel and the supporting battens. This should extend at least 5 mm beyond the supporting battens on both sides.

This constructional measure prevents permanent moisture penetration of the subframes. If these conditions are not met, the subframes must be protected according to DIN 68800-3 „Chemical wood preservation“.

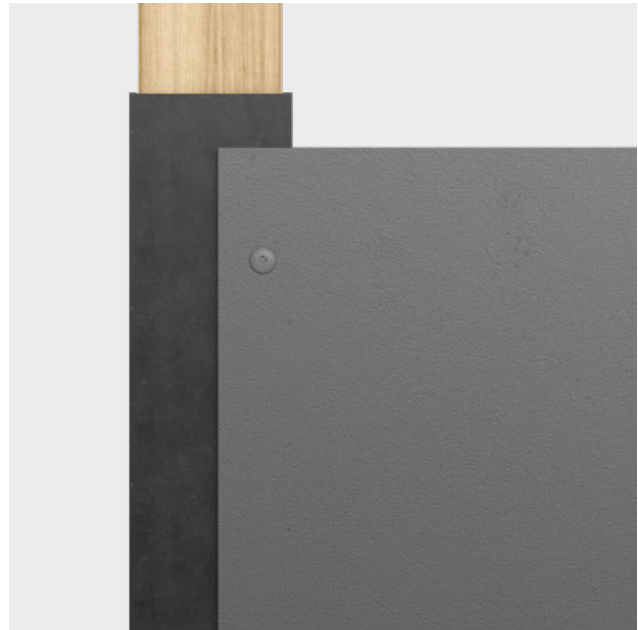

Anchoring the timber subframes in the load-bearing substrate

For anchoring the subframes in the load-bearing wall, local regulations and standards apply.



Connection of subframes

The load-bearing battens should be arranged vertically according to local standards and regulations.

Minimum cross-section of the timber subframes

Hardie® Panel and Hardie® Architectural Panel must always be installed free of constraints.

Care must be taken to ensure that the joint width between the panels is specified at the planning stage. A maximum joint width of 10mm may be used. The optimum joint width is 8mm. During installation, a uniform parallel joint pattern must be maintained. With a joint width of max. 10mm, the following minimum dimensions of the load-bearing battens result:

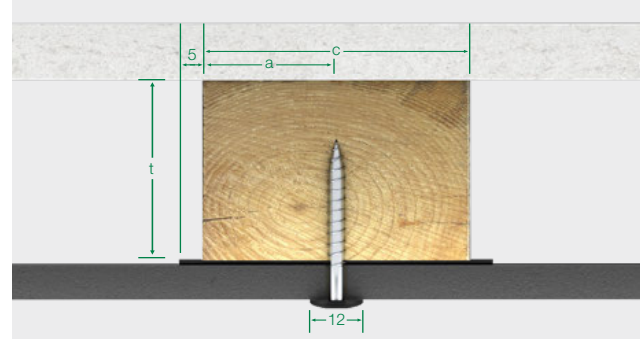
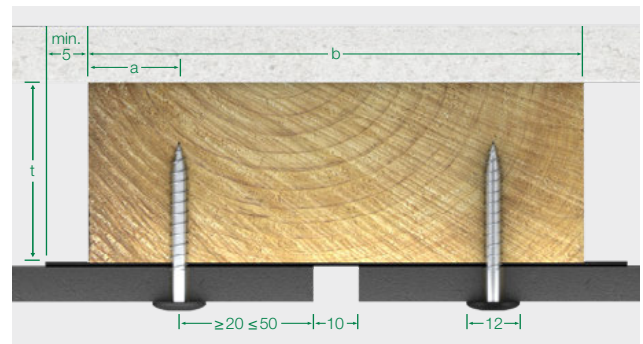

Minimum distance in mm	
Minimum thickness of the battens (t)	≥40
Minimum edge distance (a)	≥20
Minimum width of the batten (c)	≥60
Minimum width of the batten (b)	≥100

Flatness of the subframes

The horizontal tolerance according to DIN EN 18202 increased requirements for surface-finished wall cladding and suspended ceilings is +/- 3mm over a length of 2 metres.

The vertical tolerance of the subframes is +/- 1mm per 600mm.

3.2.1 Fastening to timber battens

Edge corner areas

The following distances apply:

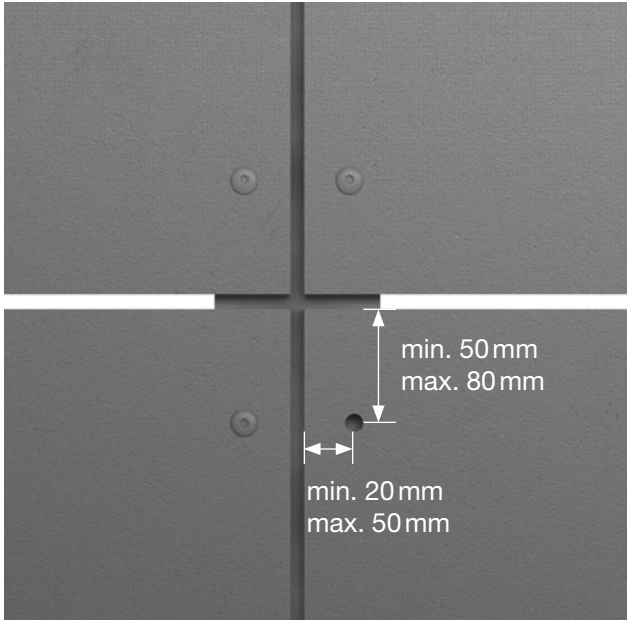

Minimum and maximum edge and corner distances

On a wooden subframe, no sliding points need to be provided in the panel.

It is recommended to mark the fixing points on the facade panel in advance. When marking the fastening points, make sure that the marks are smaller than the head of the fastener.



When marking, make sure that the marking is smaller than the fastener

Removing the markings later can damage the paint coating.

Pre-drilling

When fixing Hardie® Panel & Hardie® Architectural Panel to timber subframes, the cladding panels can be pre-drilled, but this is not essential.

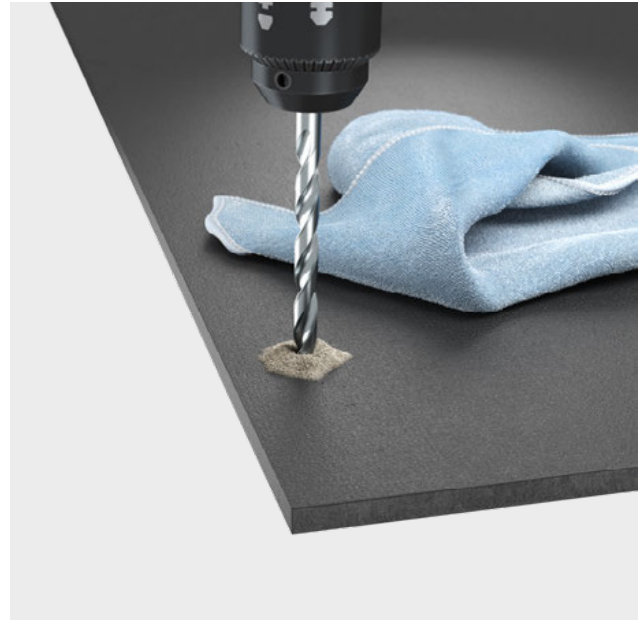

Remove drilling dust from the surface immediately

Dust from drilling must be removed immediately, otherwise traces may remain on the surface.

The drill diameter for timber subframe is max. 4mm

The Hardie™ Panel screws are to be hand-guided when screwing in with the appropriate Torx 20 bit, the screw is screwed in with moderate pressure. The screw head should rest fully and flat on the panel surface. Avoid overstressing by tightening too firmly.

Fastener spacing

The design of the facade panel regarding the spacing of the axes and fasteners must be carried out using an object-specific structural analysis.

The maximum centre distance and fastener spacing of Hardie® Panel & Hardie® Architectural Panel is 625 mm.

- 1 Load-bearing substrate
- 2 Horizontally mounted counter battens
- 3 Vertically mounted support battens
- 4 EPDM tape
- 5 Insulation material
- 6 Hardie® Shield (optional)
- 7 In accordance with building regulations



Wind load table

The following tables are a non-binding aid for the panel format shown (3048 mm × 1 220 mm). Calculation must always be provided for the specific project. The fastener spacing is influenced by the choice of subframes, as well as its bearings and anchoring. The absorption of wind loads according to EN 1991-1-4 and the national appendix must be verified for all components.

Possible characteristic wind suction load [kN/m²] for panel thickness 8 mm

Hardie® Panel and Hardie® Architectural Panel 8 mm Facade panel - mounted on edge with Hardie™ timber screw on wooden subframes				
fixings per subframe		spacing of subframe [mm]		
Quantity	spacing [mm]	300	400	600
11	295	1.33	1.03	0.61
10	327	1.22	0.93	0.55
9	368	1.09	0.84	0.50
8	421	0.95	0.73	0.43
7	491	0.81	0.62	0.37
6	589	0.68	0.51	0.30
5	625	0.53	0.41	0.24

Boundary conditions for the calculation:
 Panel format = 1 220 mm × 3048 mm
 Substructure mounted on edge, 3048 mm long, as a 4-bay support,
 Wall bracket spacing: 637 mm
 Timber substructure: C24 40/60

Hardie® Panel and Hardie® Architectural Panel 8 mm Facade panel - mounted cross with Hardie™ timber screw on wooden subframes					
fixings per subframe		spacing of subframe [mm]			
Quantity	spacing [mm]	300	400	600	625
6	224	1.69	1.17	0.83	0.79
5	284	1.36	0.95	0.68	0.64
4	373	1.07	0.74	0.53	0.51
3	560	0.64	0.45	0.32	0.30

Boundary conditions for the calculation:
 Panel format = 1 220 mm × 3048 mm
 or 1 200 mm × 2 540 mm for 625 mm substructure spacing
 Substructure mounted on edge, 2 450 mm long, as 3-span support,
 Wall bracket spacing: 637 mm
 Timber substructure: C24 40/60

Possible characteristic wind suction load [kN/m²] for panel thickness 11 mm

Hardie® Panel and Hardie® Architectural Panel 11 mm Facade panel - mounted on edge with Hardie™ timber screw on wooden subframes				
fixings per subframe		spacing of subframe [mm]		
Quantity	spacing [mm]	300	400	600
11	295	4.11	3.13	1.84
10	327	3.83	2.91	1.72
9	368	3.48	2.64	1.57
8	421	3.05	2.31	1.38
7	491	2.60	1.95	1.16
6	589	2.15	1.61	0.96

Boundary conditions for the calculation:
 Panel format = 1 220 mm × 3048 mm
 Substructure mounted on edge, 3048 mm long, as a 4-bay support,
 Wall bracket spacing: 637 mm
 Timber substructure: C24 40/60

Hardie® Panel and Hardie® Architectural Panel 11 mm Facade panel - mounted cross with Hardie™ timber screw on wooden subframes					
fixings per subframe		spacing of subframe [mm]			
Quantity	spacing [mm]	300	400	600	625
6	224	4.95	3.41	2.40	2.28
5	284	4.04	2.80	1.98	1.89
4	373	3.36	2.32	1.65	1.58
3	560	2.05	1.42	1.00	0.96

Boundary conditions for the calculation:
 Panel format = 1 220 mm × 3048 mm
 or 1 200 mm × 2 540 mm for 625 mm substructure spacing
 Substructure mounted on edge, 2 450 mm long, as 3-span support,
 Wall bracket spacing: 637 mm
 Timber substructure: C24 40/60

3.2.2 Technical specifications/details

I. General spacings

Please refer to the specified spacings in this brochure.

Hardie® Panel and Hardie® Architectural Panel should project 10 mm below (at the base) and above (at the roof) the subframes.

For flat roofs, balconies and similar where water can run off, the distance should be at least 50 mm.

The distance to window sills and lintels must be at least 10 mm.

For vertical connections of the facade panels to profiles or other building components, the distance must be at least 4 mm.

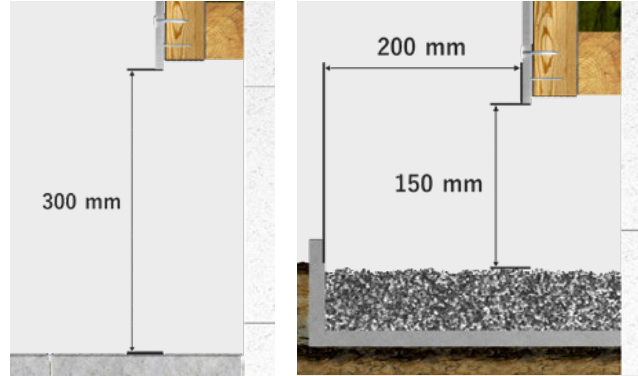

The lower edge of the facade panel is advised to be placed with at least 300 mm distance in the splash water area or 150 mm in case of a surrounding gravel bed.

II. External corner with open joint:

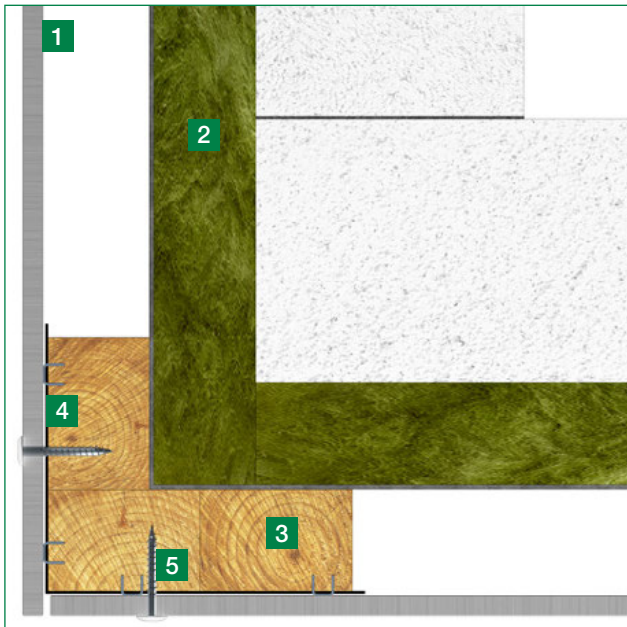

- 1 Hardie® Panel or Hardie® Architectural Panel
- 2 Insulation
- 3 Vertical battens min. 40 × 60 mm
(For panel joints min. 100 × 60 mm)
- 4 Hardie™ EPDM tape
- 5 Hardie™ panel screws (for timber frames)

For the outside corner with an open joint, a joint width of min. 4 mm must be maintained. The Hardie™ EPDM tape must be used over the entire width of the subframes (5 mm overhang on both sides).

III. External corner with Hardie™ Panel MetalTrim™

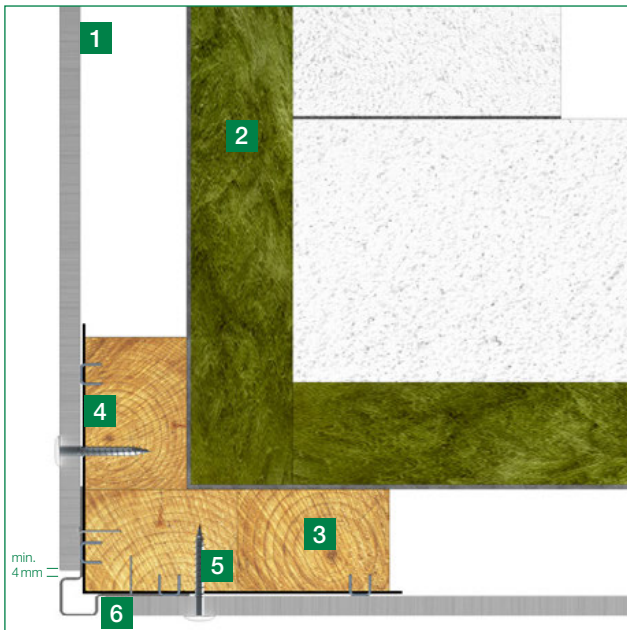

- 1 Hardie® Panel or Hardie® Architectural Panel
- 2 Insulation
- 3 Vertical battens min. 40×60 mm
(For panel joints min. 100×60 mm)
- 4 Hardie™ EPDM tape
- 5 Hardie™ panel screws (for timber frames)
- 6 Hardie™ Panel MetalTrim™ trim strips for external corners

For the outside corner solution with Hardie™ Panel MetalTrim™ trim for outside corners, a joint width of min. 4 mm must be maintained between the outer edge of the facade panel and the profile.

IV. Inside corner with open joint:

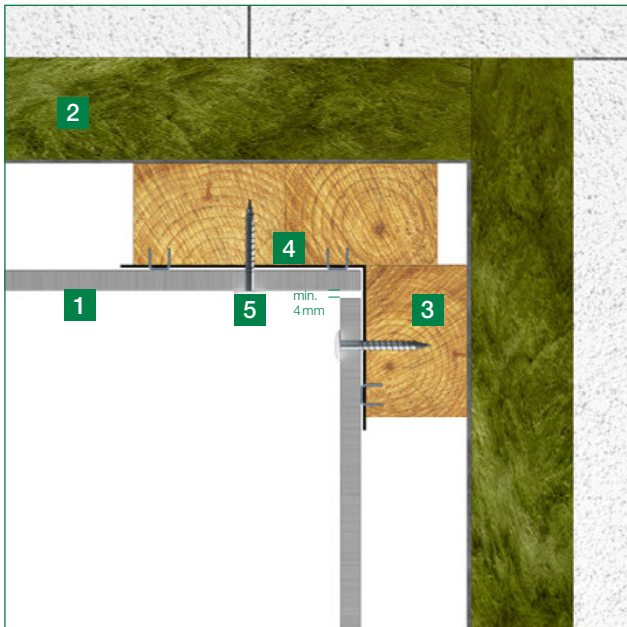

- 1 Hardie® Panel or Hardie® Architectural Panel
- 2 Insulation
- 3 Vertical battens min. 40×60 mm
(For panel joints min. 100×60 mm)
- 4 Hardie™ EPDM tape
- 5 Hardie™ panel screws (for timber frames)

For the inside corner solution with open joint, a joint width of min. 4 mm must be maintained. The Hardie™ EPDM tape must be used over the entire width of the subframes (5 mm projection on both sides).

V. Inside Corner with Hardie™ Panel MetalTrim™

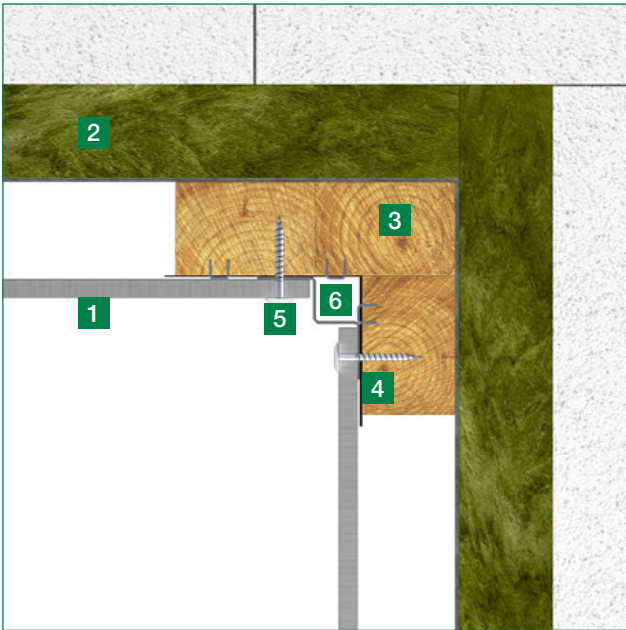

- 1 Hardie® Panel or Hardie® Architectural Panel
- 2 Insulation
- 3 Vertical battens min. 40 × 60 mm
(For panel joints min. 100 × 60 mm)
- 4 Hardie™ EPDM tape
- 5 Hardie™ panel screws (for timber frames)
- 6 Hardie™ Panel MetalTrim™ trim strips for inside corners

For the inside corner solution with Hardie™ Panel MetalTrim™ trim for inside corners, a joint width of min. 4 mm must be maintained between the outer edge of the facade panel and the profile.

VI. Base section

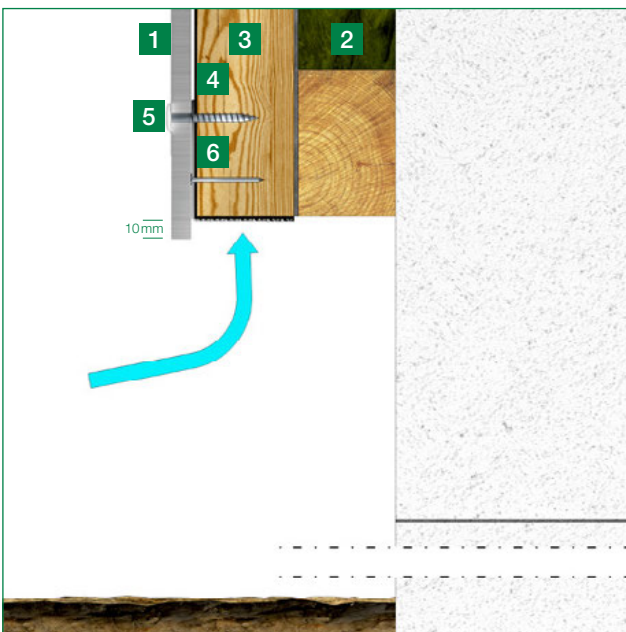

- 1 Hardie® Panel or Hardie® Architectural Panel
- 2 Insulation
- 3 Vertical battens min. 40 × 60 mm
(For panel joints min. 100 × 60 mm)
- 4 Hardie™ EPDM tape
- 5 Hardie™ panel screws (for timber frames)
- 6 Ventilation profile for Hardie™ Panel

Ensure that the cladding panel overlaps the subframes by 10 mm to allow water to drip off the cladding. Ventilation profiles must be installed to prevent small rodents from entering.

VII. Fascia

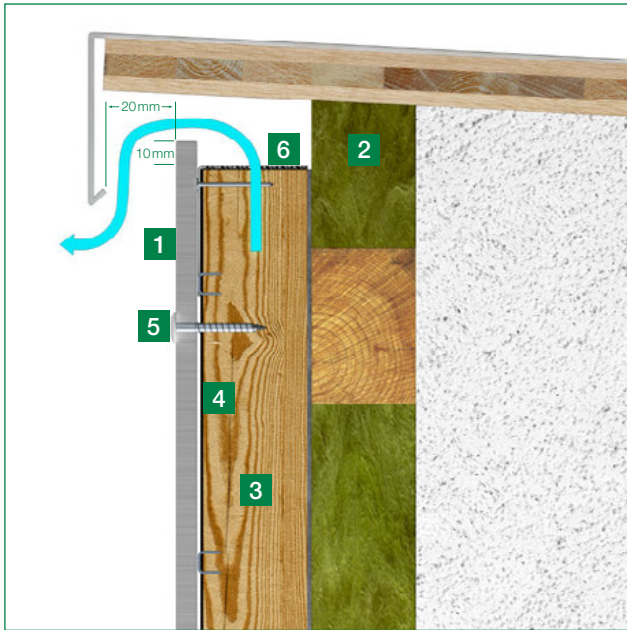

- 1 Hardie® Panel or Hardie® Architectural Panel
- 2 Insulation
- 3 Vertical battens min. 40×60 mm
(For panel joints min. 100×60 mm)
- 4 Hardie™EPDM tape
- 5 Hardie™ panel screws (for timber frames)
- 6 Ventilation profile for Hardie™ Panel

be used to ensure rear ventilation. A gap of min. 10mm must be ensured from the upper edge of the facade panel to the lower edge of the parapet formation. We recommend the use of a ventilation grille also in the upper area of the facade. The drip edge of the parapet should be at least 20mm in front of the facade. The overlap must be min. 50mm.

It must be ensured that the air can flow freely behind the facade panel. The facade panel must protrude at least 10mm above the subframes. A ventilation cross-section of min. 50cm² per running metre must

Usually flashings overlap min. 50mm up to 8m, min. 80mm up to 20m and min. 100mm from 20m building height. Local regulations apply.

VIII. Window reveal with open joint

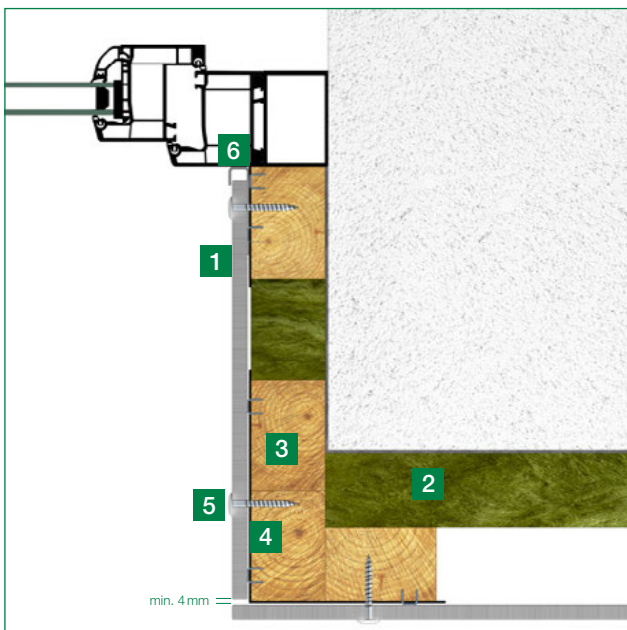

- 1 Hardie® Panel or Hardie® Architectural Panel
- 2 Insulation
- 3 Vertical battens min. 40×60 mm
(For panel joints min. 100×60 mm)
- 4 Hardie™EPDM tape
- 5 Hardie™ panel screws (for timber frames)
- 6 Suitable U-profile

It is recommended to fix the reveal strip of Hardie® Panel or Hardie® Architectural Panel to the window frame with a U-profile. The timber subframes in the corner area must be provided with the Hardie™ EPDM tape over the entire width. The width of the joint at the corners between the facade panels should not be less than 4mm.

IX. Window reveal with Hardie™ Panel MetalTrim™

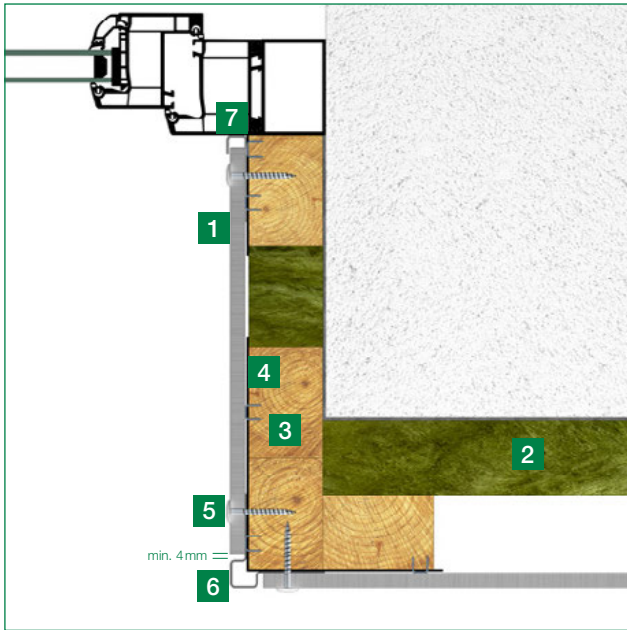

- 1 Hardie® Panel or Hardie® Architectural Panel
- 2 Insulation
- 3 Vertical battens min. 40 × 60 mm
(For panel joints min. 100 × 60 mm)
- 4 Hardie™ EPDM tape
- 5 Hardie™ panel screws (for timber frames)
- 6 Hardie™ Panel MetalTrim™ trim strips for external corners
- 7 Suitable U-profile

When forming the window reveal with Hardie™ Panel MetalTrim™ trim for external corners, a joint width of min. 4 mm must be maintained between the outer edge of the facade panel and the profile.

X. Window Sill

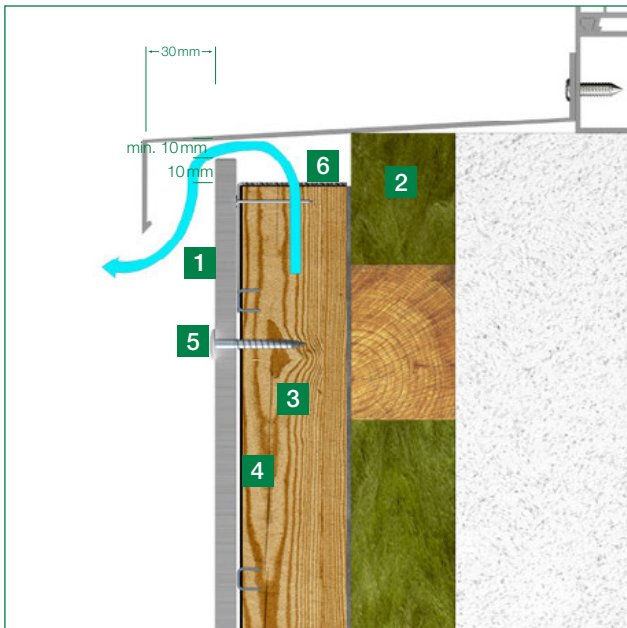

- 1 Hardie® Panel or Hardie® Architectural Panel
- 2 Insulation
- 3 Vertical battens min. 40 × 60 mm
(For panel joints min. 100 × 60 mm)
- 4 EHardie™ PDM tape
- 5 Hardie™ panel screws (for timber frames)
- 6 Ventilation profile for Hardie™ Panel

The facade cladding must protrude 10 mm above the subframes at the top. To avoid soiling, we recommend that the windowsill protrudes at least 30 mm above the facade.

There should be at least a gap of 10 mm or 50 cm² per metre between the upper facade panel and the windowsill for sufficient ventilation.

Hardie® Panel and Hardie® Architectural Panel must not be used as a window sill!

XI. Window lintel

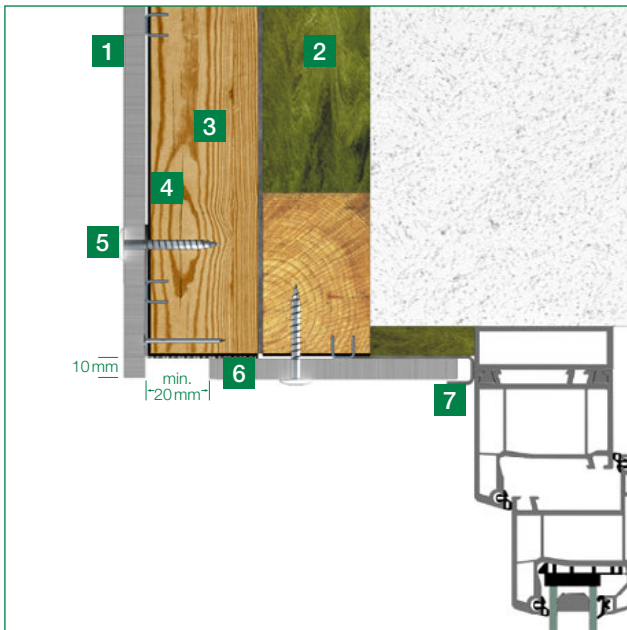

- 1 Hardie® Panel or Hardie® Architectural Panel
- 2 Insulation
- 3 Vertical battens min. 40×60 mm
(For panel joints min. 100×60 mm)
- 4 Hardie™ EPDM tape
- 5 Hardie™ panel screws (for timber frames)
- 6 Ventilation profile for Hardie™ Panel
- 7 Suitable U-profile

The cladding panels can be fixed with the Hardie™ Panel screw for timber subframes, as on the window reveals. At the window frame, the pan-

els can be inserted into a U-profile. A ventilation gap of min. 20mm must be made at the front edge of the panel to the facade side. Use Hardie™ ventilation profiles to ensure that no small animals can enter the rear ventilation level.

XII. Window lintel with integrated blinds

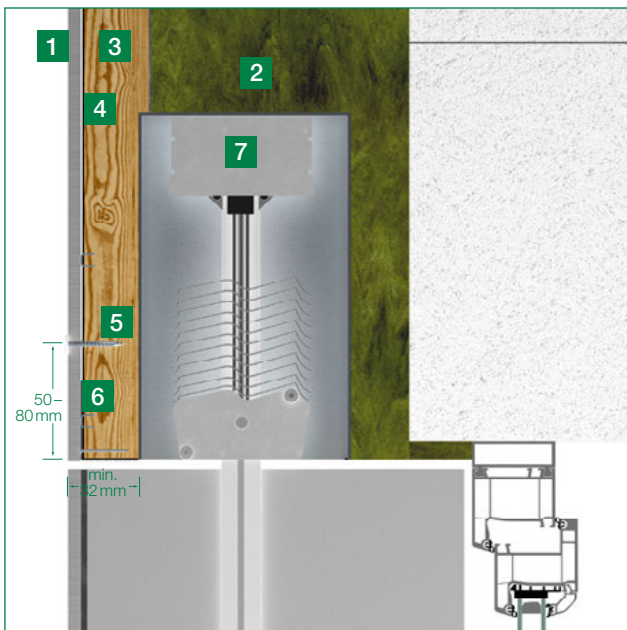

- 1 Hardie® Panel or Hardie® Architectural Panel
- 2 Insulation
- 3 Vertical battens min. 40×60 mm
(For panel joints min. 100×60 mm)
- 4 Hardie™ EPDM tape
- 5 Hardie™ panel screws (for timber frames)
- 6 Ventilation profile for Hardie™ Panel
- 7 Integrated blind system

In the case of an integrated louvre, the subframes of the Hardie® Panel and Hardie® Architectural Panel must be routed across the louvre box.

Due to the length of the fasteners, care must be taken to ensure that the subframes have a depth of at least 32 mm.

The facade panels must not project freely over the blind box or be fastened in the blind box. This will cause damage to the facade panel and insufficient rear ventilation will be guaranteed in this area.

XIII. Window lintel with integrated roller shutter

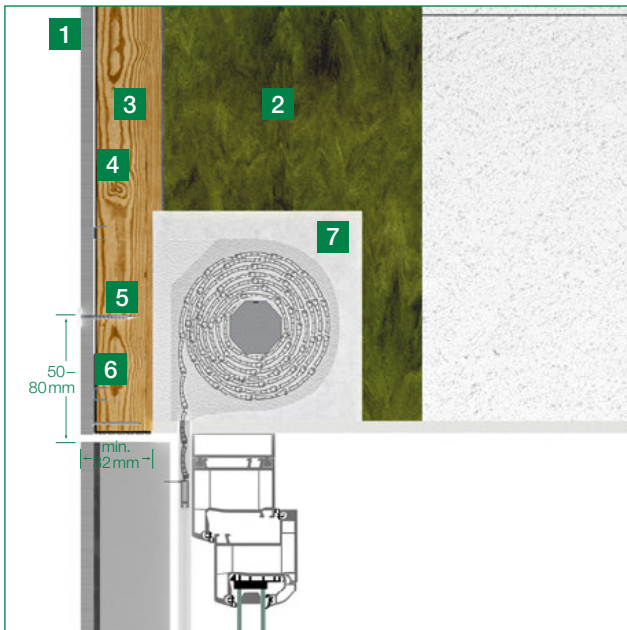

- 1 Hardie® Panel or Hardie® Architectural Panel
- 2 Insulation
- 3 Vertical battens min. 40 × 60 mm
(For panel joints min. 100 × 60 mm)
- 4 Hardie™ EPDM tape
- 5 Hardie™ panel screws (for timber frames)
- 6 Ventilation profile for Hardie™ Panel
- 7 Integrated roller shutter system

As with an integrated blind, the subframes of the facade panels must be routed over the roller shutter box to ensure sufficient rear ventilation and to prevent damage to the panel.

3.3 Aluminium subframes

The same principles as for aluminium subframes also apply for steel subframes. For questions please contact our technical team.

In the event of fastening the Hardie® Panel and Hardie® Architectural Panel to an aluminium sub-frame, the facade panels are preferably fastened to the subframes with Hardie™ Rivet or Hardie™ Screw for aluminium.

The fastener heads are matched to the respective colour of the facade panels.

General

Hardie® Panel is not intended as a load bearing or shear element in the wall construction. Items required to be attached to the wall should be supported directly by connections to the structural sheathing and/or framing members, not attached to the cladding as the primary load bearing elements. Lightweight finishing grilles can be bonded to the face of the product using a construction adhesive.

Anchoring the aluminium subframes in the load-bearing substrate

For anchoring the wall brackets in the load-bearing substrate, dowels (screw-dowel combinations) approved/rated by the building authorities must be used.



General set-up

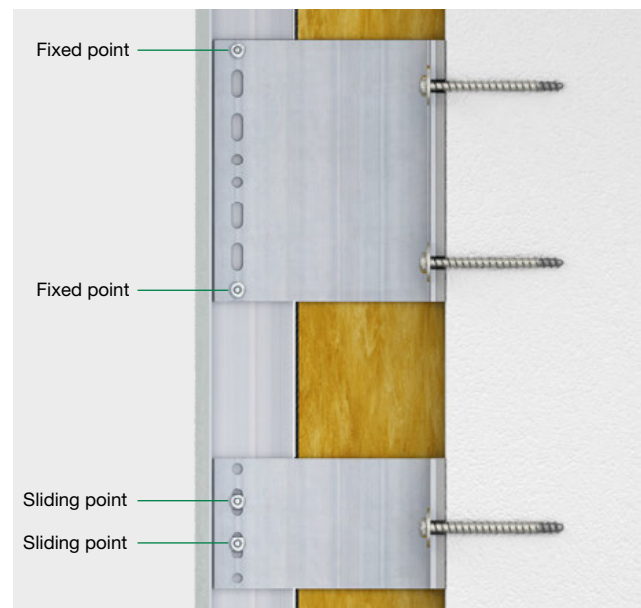

Arrangement of fixed and sliding points of the subframe

Connection of wall bracket and support profile

When connecting the wall bracket and the support profile, use tested connecting elements in accordance with the manufacturer's specifications.

For a visually appealing result, it is recommended to use support profiles with a black coated visible surface at the factory.

After attaching the wall brackets, the support profiles are aligned and fixed to the wall brackets with a straight edge considering tolerances as per local regulations.

Hardie® Panel and Hardie® Architectural Panel may only be fixed at the same time to support profiles whose fixed points are at the same height.

For this reason, a separation of the profiles must be planned, e.g. at window parapets, in order to avoid joints of the profiles below the facade panel.

Typically, the supporting profiles of an aluminium subframes for Hardie® Panel and Hardie® Architectural Panel consist of T-profiles around the panel joint and L-profiles in the centre of the panel.

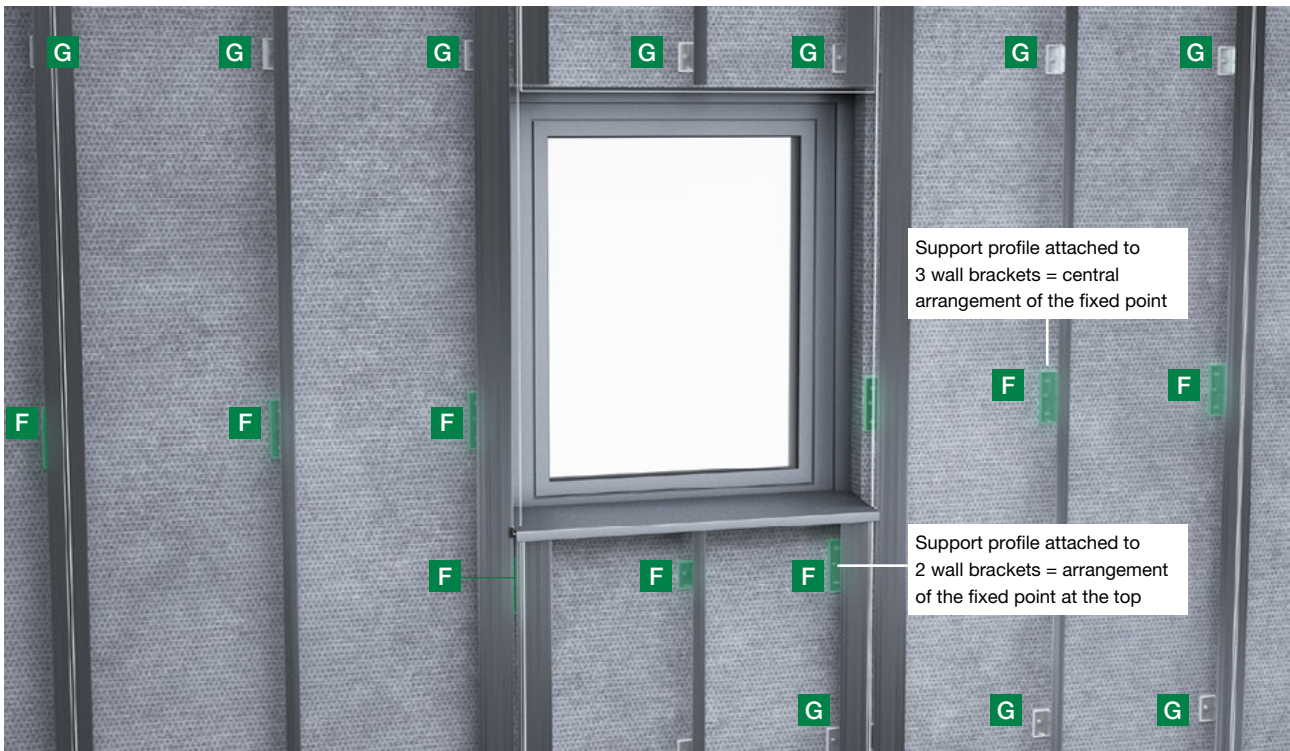

Stylistic arrangement of the panels: The wall brackets (F) marked in green show the position of the fixed points of the support profiles as an example. All other fixings on the wall brackets must be designed as sliding points.

There must be at least 20 mm distance between 2 support profiles.

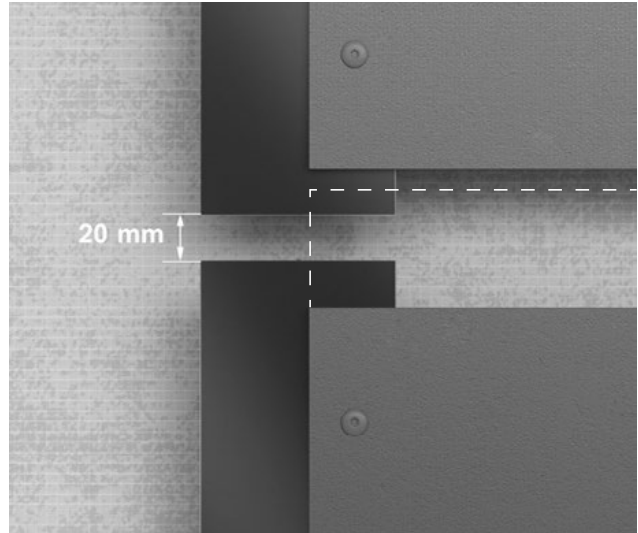

The T-profile behind the joints must be at least 100 mm wide, the L-profile in the panel field at least 40 mm wide. A maximum joint width of 10 mm is allowed. The optimum joint width is 8 mm.

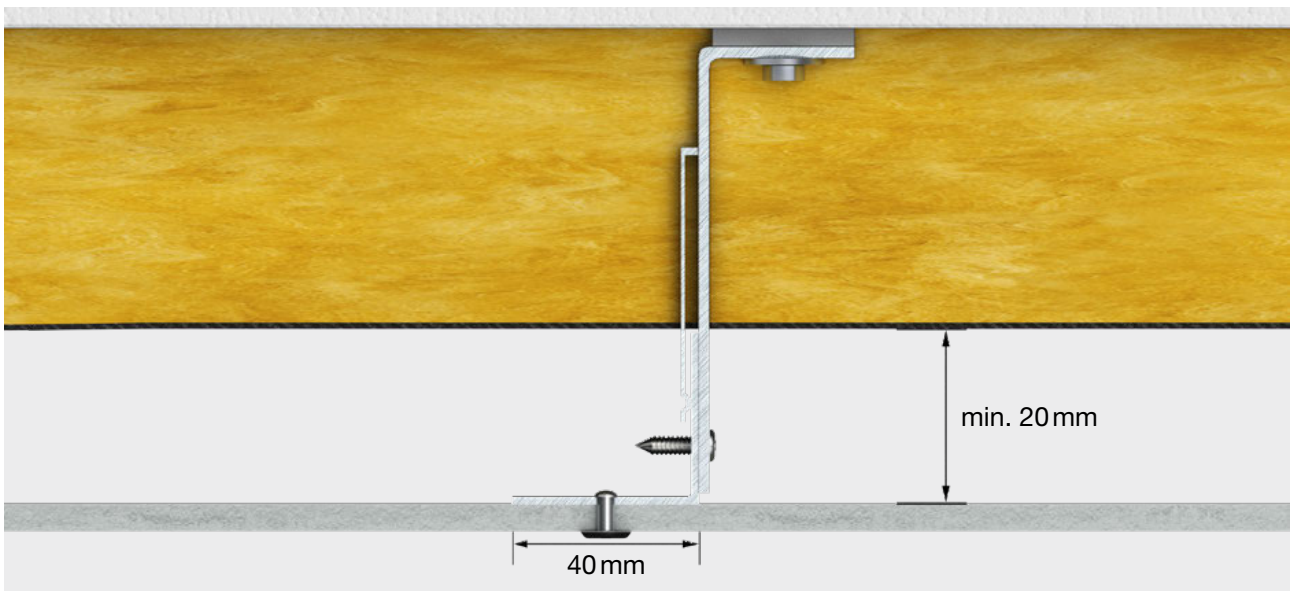
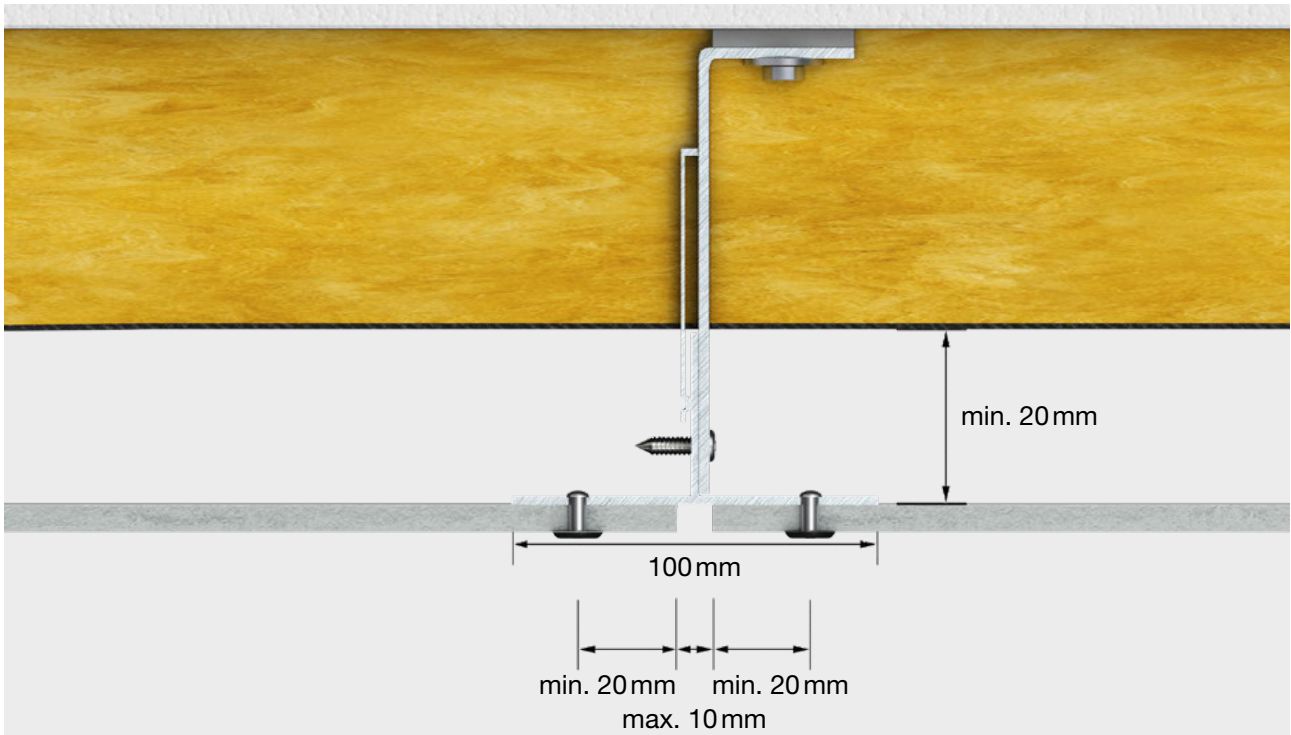

3.3.1 Fastening to aluminium subframes with Hardie™ rivet

Hardie® Panel and Hardie® Architectural Panel elements must never be fixed above a horizontal joint of two vertical support profiles. Otherwise, when the support profiles are coupled, stresses can arise which can cause damage to the panel.

Due to thermal expansion of the entire system, a horizontal joint must be planned in the facade cladding and the subframes at storey level (at least every 3000 mm). There are different variants of a horizontal interruption.

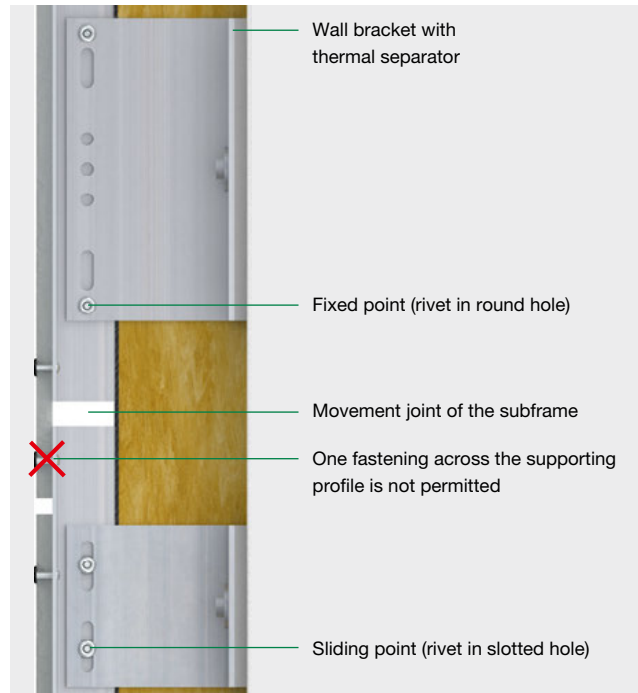

Possible variants of a horizontal interruption

Variant 1



Profile joint = panel joint

Variant 2

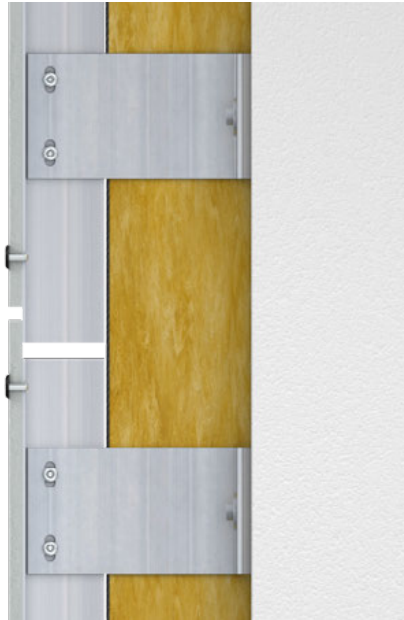

Profile joint concealed

Variant 3



Concealed profile joint with combination connection on a wall bracket

Hardie® Panel and Hardie® Architectural Panel is fixed with two fixed points. All other fastener points are to be designed as sliding points.

To use the same pre-drilling for aligning points as well as fix points, a drilling diameter of Ø 9.5 mm in combination with the Hardie™ fixed point sleeve can be used.

Alternatively fixing points can be drilled with a diameter of 5,1 mm, equal to the holes in the support profile to build up the 2 fixing points per panel

Fixed point

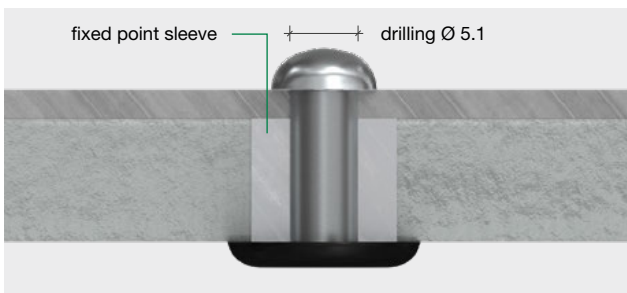

Sliding point

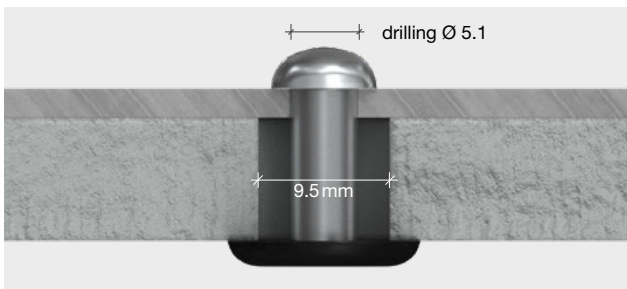

Edge corner areas

The following distances apply:

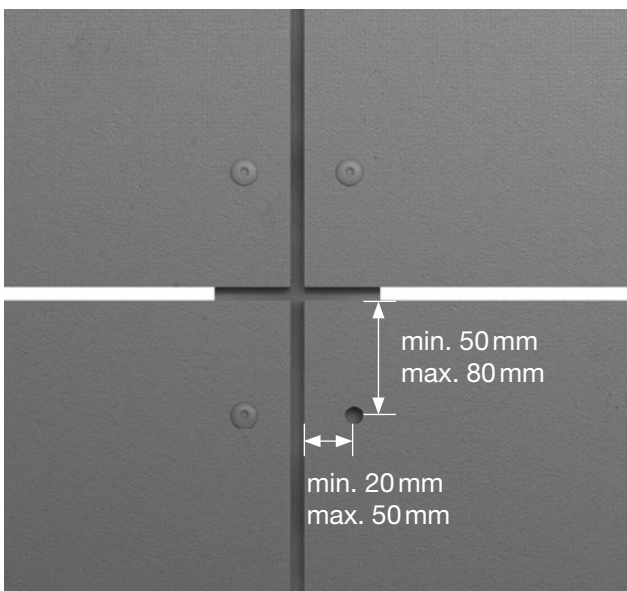

Minimum and maximum edge and corner distances

The facade panels are fastened with the Hardie™ panel rivet for aluminum in 5 × 16 mm, head diameter 14 mm.

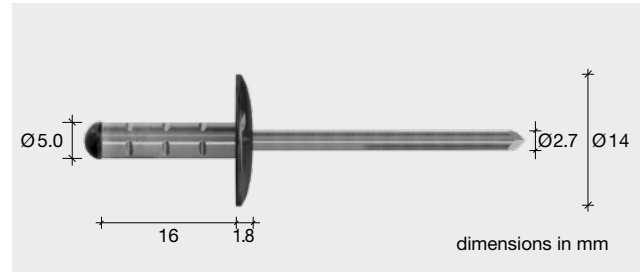

Hardie™ Panel rivet for aluminum blind rivets:

- according to ETA-13/0255
- Ø5.0 × 16.0 mm, K14

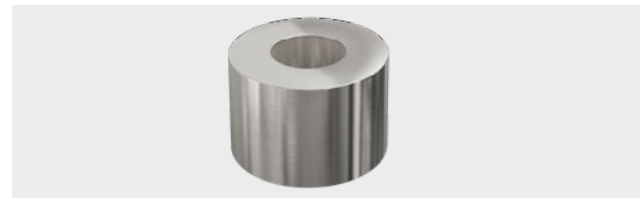

The Hardie™ fixed point sleeve can be used to form the two fixed points.

Pre-drilling

When fixing Hardie® Panel & Hardie® Architectural Panel cladding to an aluminium subframe, the cladding panels are pre-drilled lying flat on a level, pressure-resistant substrate.

Dust from drilling must be removed immediately, otherwise traces may remain on the surface.

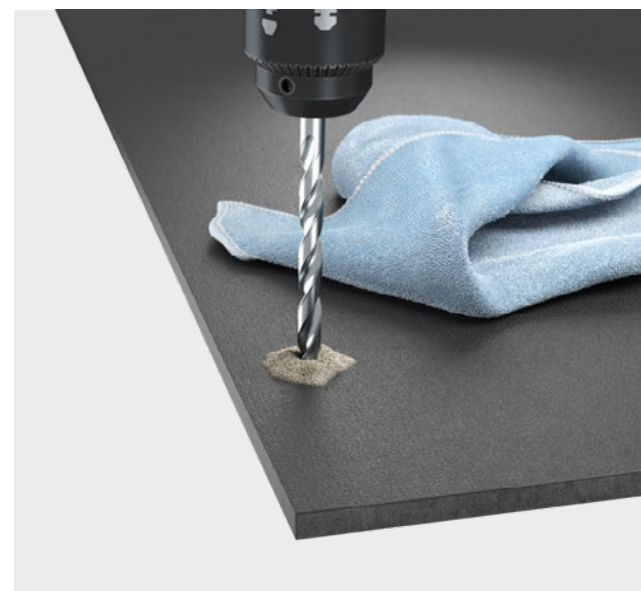

Remove drilling dust from the surface immediately

Installation procedure

We recommend installing the facade panels on the building from top to bottom. This has the following advantages:

- The panels can be set up on a horizontally aligned straight edge.
- Lower risk of damage and contamination.
- Dismantling scaffolding in parallel

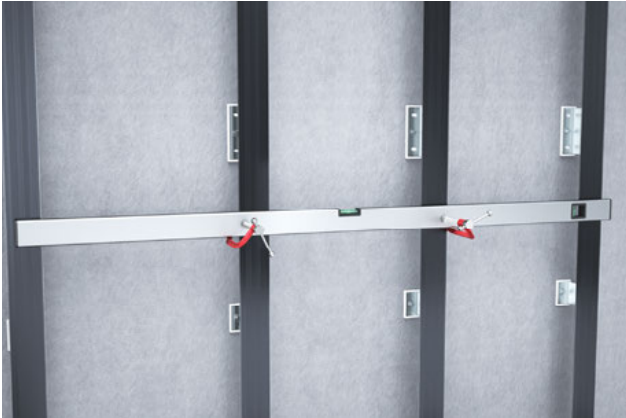

The hole in the aluminum subframe must be centered for example by using the Hardie™ Centralising Tool.



Finally, the facade rivet is set using a rivet setting tool. If holes are pre-drilled in 9,5 mm diameter, insert the Hardie™ fixed point sleeve before fixing the rivet. The rivet head must lie flat on the surface of the facade panel.

Please note that there are different nosepieces for the rivet setting tool for fixed and sliding points.

Care must be taken to ensure that these are selected accordingly. The different nose pieces ensure the correct distance between the rivet head and the facade panel.

The panel fixed points should preferably be located in the centre of the panels in the area of the fixed points within the subframes and should be on a horizontal line.

All other fixing points are designed as sliding points. To make the fastening as constraint-free as possible, the fasteners should be set in a circle from the inside to the outside.

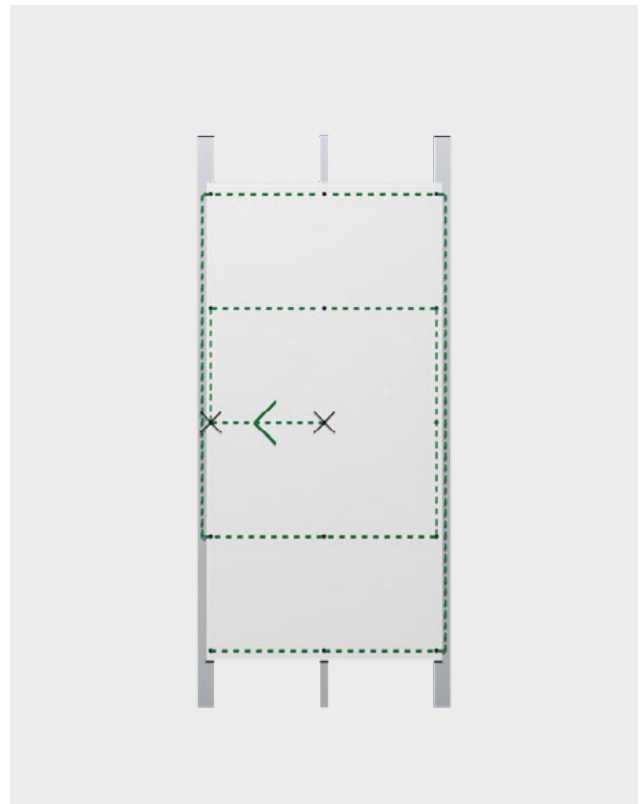

Sequence of rivet fastening, the crosses mark the fixed points

Example of vertically mounted panels:

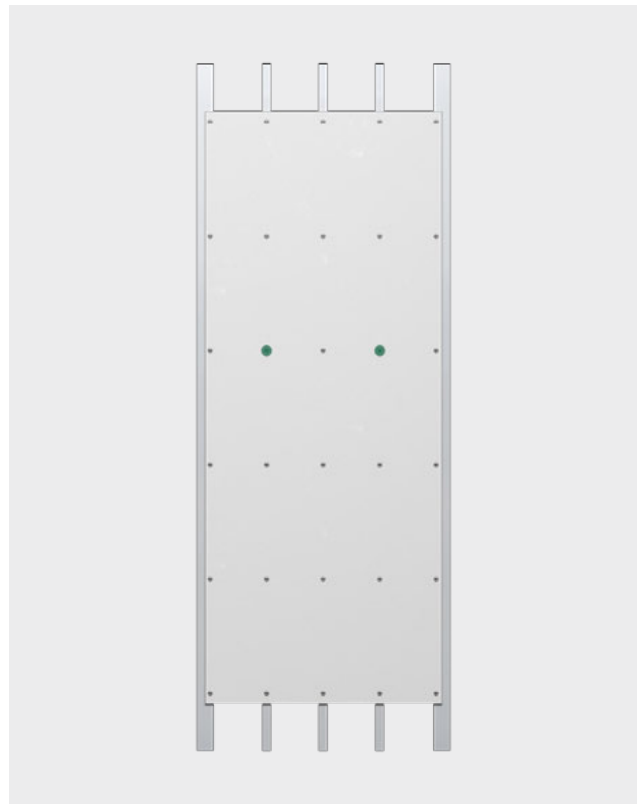
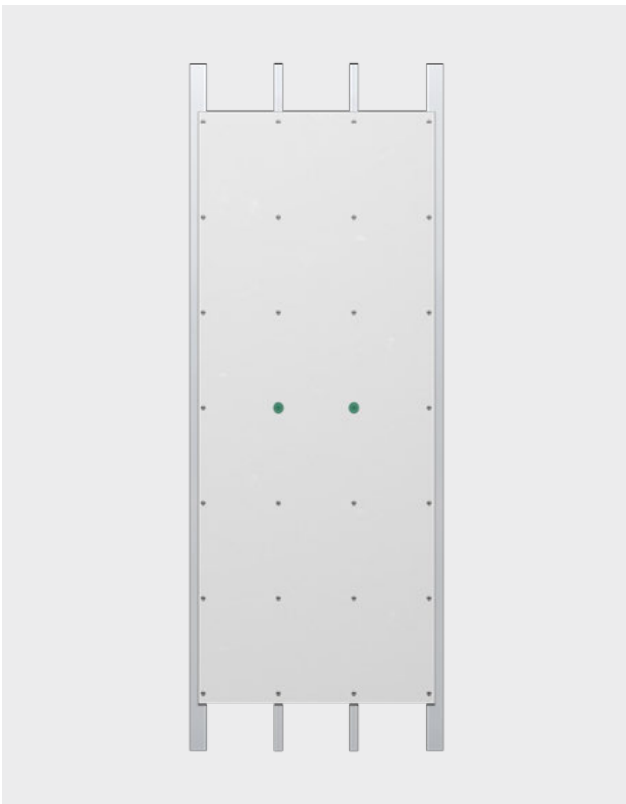
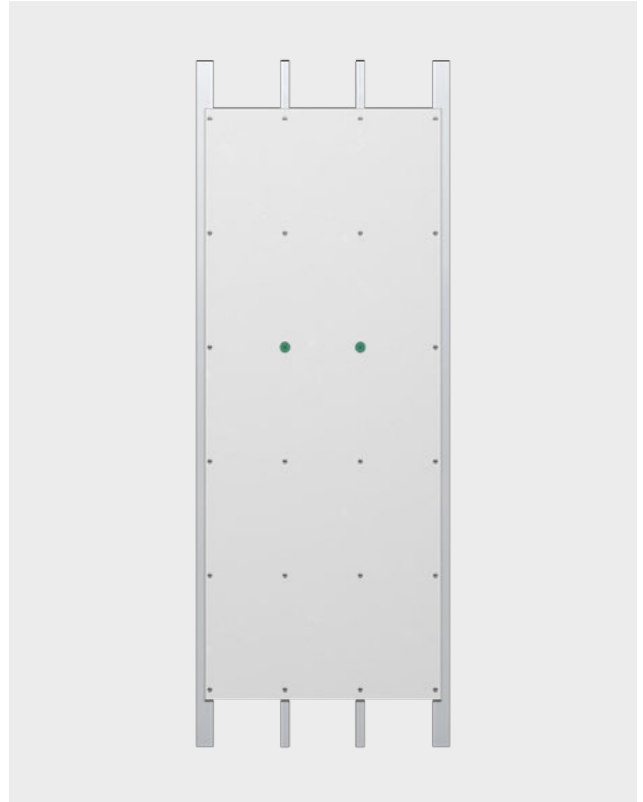
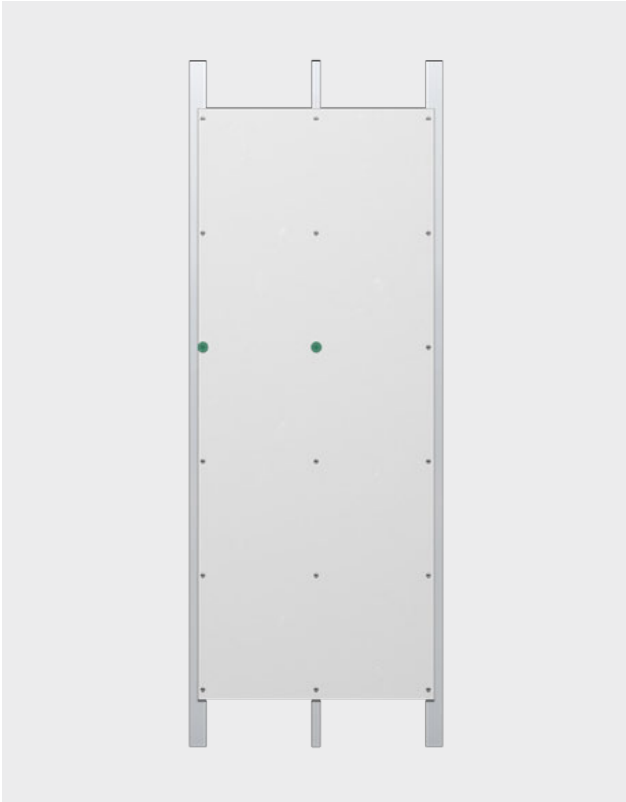

Example of horizontally mounted panels:

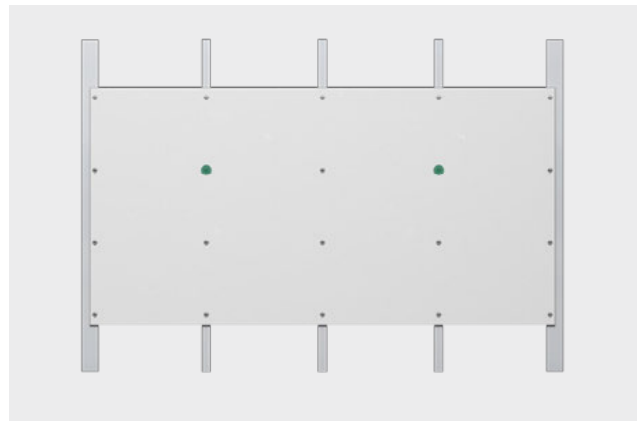
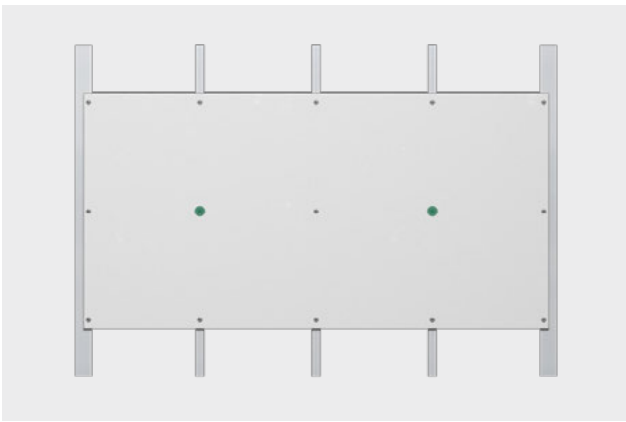
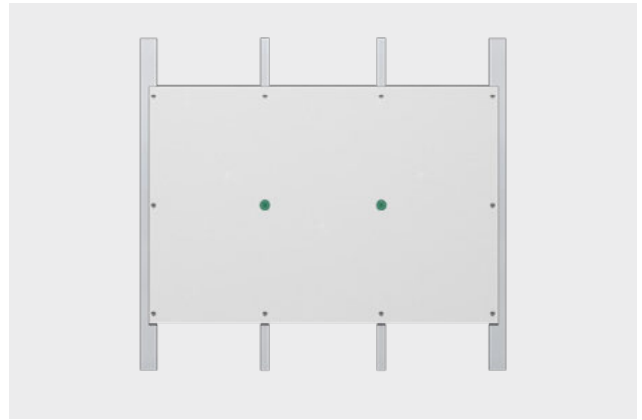
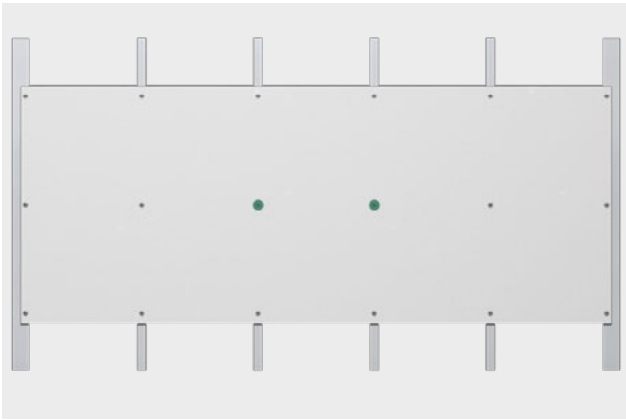

Wind load tables

The following tables are a non-binding aid for the panel format shown (3048 mm × 1 220 mm). Calculations must always be provided for the specific project. The fastener spacing is influenced by the choice of subframes, as well as its bearings and anchoring. The absorption of wind loads according to EN 1991-1-4 and the national appendix must be verified for all components.

Possible characteristic wind suction load [kN/m²] for panel thickness 8 mm

Hardie® Panel and Hardie® Architectural Panel 8 mm - mounted on edge with Hardie™ rivet on aluminum subframe				
fixings per subframe		spacing of subframe [mm]		
Quantity	spacing [mm]	300	400	600
11	295	1.64	1.26	0.73/0.61*
10	327	1.53	1.17	0.69/0.58*
9	368	1.41	1.09	0.63/0.54*
8	421	1.30	0.98	0.57/0.49*
7	491	1.11	0.84	0.50/0.43*
6	589	0.92	0.70	0.41/0.36*
5	625	0.72	0.55	0.33/0.28*

Boundary conditions for the calculation:

Panel format = 1 220 mm × 3 048 mm

Substructure: Aluminum L-profile 50/42/2, mounted on edge, 3 048 mm long, as a 4-field support, wall bracket spacing: 637 mm

* Values apply to the Hardie® Architectural Panel

Hardie® Panel and Hardie® Architectural Panel 8 mm - cross-mounted with Hardie™ rivet on aluminum subframe					
fixings per subframe		spacing of subframe [mm]			
Quantity	spacing [mm]	300	400	600	625
6	224	1.94	1.35	0.97	0.92
5	284	1.67	1.17	0.83	0.79
4	373	1.37	0.94	0.67	0.64
3	560	0.84	0.61	0.43/0.39*	0.41/0.38*

Boundary conditions for the calculation:

Panel format = 1 220 mm × 3 048 mm

or 1 200 mm × 2 540 mm for 625 mm substructure spacing

Substructure: aluminum L-profile 50/42/2 mounted on edge, 2 450 mm long, as 3-span support, wall bracket spacing: 650 mm

* Values apply to the Hardie® Architectural Panel

Possible characteristic wind suction load [kN/m²] for panel thickness 11 mm

Hardie® Panel and Hardie® Architectural Panel 11 mm Facade panel - mounted on edge with Hardie™ rivet on aluminium subframes				
fixings per subframe		spacing of subframe [mm]		
Quantity	spacing [mm]	300	400	600
11	295	5.06	3.85	2.27
10	327	4.72	3.59	2.12
9	368	4.29	3.26	1.93
8	421	3.75	2.85	1.70
7	491	3.20	2.40	1.43
6	589	2.65	1.99	1.18

Boundary conditions for the calculation:

Panel format = 1 220 mm × 3 048 mm

Substructure mounted on edge, 3 048 mm long, as a 4-bay support,

Wall bracket spacing: 637 mm

Timber substructure: C24 40/60

Hardie® Panel and Hardie® Architectural Panel 11 mm Facade panel - mounted cross with Hardie™ rivet on aluminium subframes					
fixings per subframe		spacing of subframe [mm]			
Quantity	spacing [mm]	300	400	600	625
6	224	6.09	4.20	2.95	2.81
5	284	4.97	3.46	2.44	2.33
4	373	4.14	2.86	2.04	1.94
3	560	2.53	1.74	1.24	1.19

Boundary conditions for the calculation:

Panel format = 1 220 mm × 3 048 mm

or 1 200 mm × 2 540 mm for 625 mm substructure spacing

Substructure mounted on edge, 2 450 mm long, as 3-span support,

Wall bracket spacing: 637 mm

Timber substructure: C24 40/60

3.3.2 Fastening to aluminium subframes with Hardie™ Panel screw

The facade panels can also be fixed to an aluminium subframe using the self-drilling Hardie™ Panel screw for aluminium subframe 5.5 × 25 mm, head diameter 12 mm.



Hardie® Panel and Hardie® Architectural Panel is fixed with two fixed points. All other fixing points are to be designed as sliding points. To reduce stresses in the cladding panel, James Hardie recommends pre-drilling the panel. Two fix points per panel should be pre-drilled to a maximum diameter of 5.1 mm, sliding points should be pre-drilled to 8 mm.

As Hardie™ Panel screws for aluminium subframes are self-drilling, there is no need to pre-drill the subframe.

It is recommended to mark the fixing centres before drilling to achieve a uniform fixing centre pattern on the facade. It must be ensured that the screw is always placed in the centre of the rattle fixed point.

All other specifications such as distances, dimensions of the subframes, arrangement of fixed and rattle fixed points etc. can be found in the specifications for installation with the Hardie™ Panel Rivet.

Edge corner areas

The following distances apply:

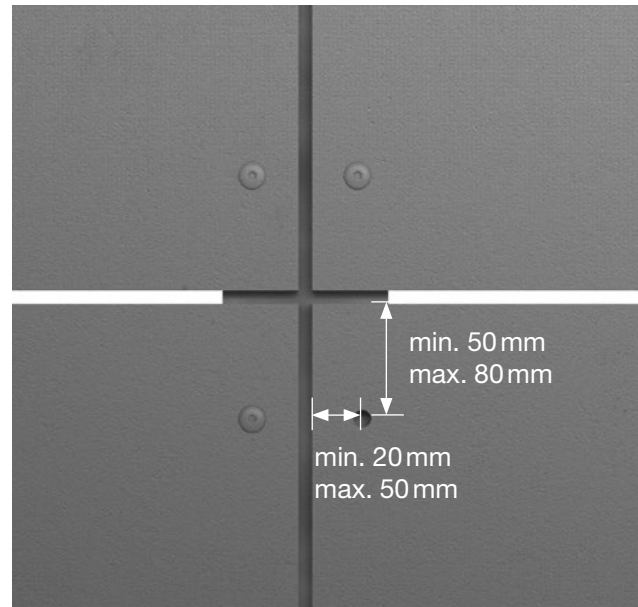

Minimum and maximum edge and corner distances

Wind load tables

The following tables are a non-binding aid for the panel format shown (3048 mm × 1 220 mm). Calculations must always be provided for the specific project. The fastener spacing is influenced by the choice of subframes, as well as its bearings and anchoring. The absorption of wind loads according to EN 1991-1-4 and the national appendix must be verified for all components.

Possible characteristic wind suction load [kN/m²] for panel thickness 8 mm

Hardie® Panel and Hardie® Architectural Panel 8 mm - mounted on edge with Hardie™ aluminium screw on aluminum subframe				
fixings per subframe		spacing of subframe [mm]		
Quantity	spacing [mm]	300	400	600
11	295	1.33	1.03	0.61
10	327	1.22	0.93	0.55
9	368	1.09	0.84	0.50
8	421	0.95	0.73	0.43
7	491	0.81	0.62	0.37
6	589	0.68	0.51	0.30
5	625	0.53	0.41	0.24

Boundary conditions for the calculation:
 Panel format = 1 220 mm × 3 048 mm
 Substructure: Aluminum L-profile 50/42/2, mounted on edge, 3 048 mm long, as 4-bay support, wall bracket spacing: 637 mm

Hardie® Panel and Hardie® Architectural Panel 8 mm - cross-mounted with Hardie™ aluminium screw on aluminum subframe					
fixings per subframe		spacing of subframe [mm]			
Quantity	spacing [mm]	300	400	600	625
6	224	1.69	1.17	0.83	0.79
5	284	1.36	0.95	0.68	0.64
4	373	1.07	0.74	0.53	0.51
3	560	0.64	0.45	0.32	0.30

Boundary conditions for the calculation:
 Panel format = 1 220 mm × 3 048 mm
 or 1 200 mm × 2 540 mm for 625 mm substructure spacing
 Substructure: aluminum L-profile 50/42/2 mounted on edge, 2 450 mm long, as 3-span support, wall bracket spacing: 650 mm

Possible characteristic wind suction load [kN/m²] for panel thickness 11 mm

Hardie® Panel and Hardie® Architectural Panel 11 mm - mounted on edge with Hardie™ aluminium screw on aluminum subframe				
fixings per subframe		spacing of subframe [mm]		
Quantity	spacing [mm]	300	400	600
11	295	4.40	3.36	1.97
10	327	4.11	3.12	1.85
9	368	3.74	2.84	1.68
8	421	3.27	2.48	1.48
7	491	2.79	2.09	1.24
6	589	2.31	1.73	1.03

Boundary conditions for the calculation:
 Panel format = 1 220 mm × 3 048 mm
 Substructure: Aluminum L-profile 50/42/2, mounted on edge, 3 048 mm long, as a 4-field support, wall bracket spacing: 637 mm
 * Values apply to the Hardie® Architectural Panel

Hardie® Panel and Hardie® Architectural Panel 11 mm - cross-mounted with Hardie™ aluminium screw on aluminum subframe					
fixings per subframe		spacing of subframe [mm]			
Quantity	spacing [mm]	300	400	600	625
6	224	5.30	3.65	2.57	2.44
5	284	4.33	3.01	2.13	2.03
4	373	3.60	2.49	1.77	1.69
3	560	2.20	1.52	1.08	1.03

Boundary conditions for the calculation:
 Panel format = 1 220 mm × 3 048 mm
 or 1 200 mm × 2 540 mm for 625 mm substructure spacing
 Substructure: aluminum L-profile 50/42/2 mounted on edge, 2 450 mm long, as 3-span support, wall bracket spacing: 650 mm
 * Values apply to the Hardie® Architectural Panel

3.3.3 Technical specifications/details

I. General spacing

Hardie® Panel and Hardie® Architectural Panel should project 10 mm below (at the base) and above (at the roof) the subframes.

The distance to the ground should be at least 150 mm from the lower edge of the cladding panel to prevent soiling and damage (in the case of surrounding gravel strips). If there is no gravel strip, a distance of at least 300 mm (splash water area) must be maintained.

For flat roofs, balconies and similar where water can run off, the distance should be at least 50 mm. The distance to windowsills and lintels must be at least 10 mm.

For vertical connections of the facade panels to profiles or other building components, the distance must be at least 4 mm.

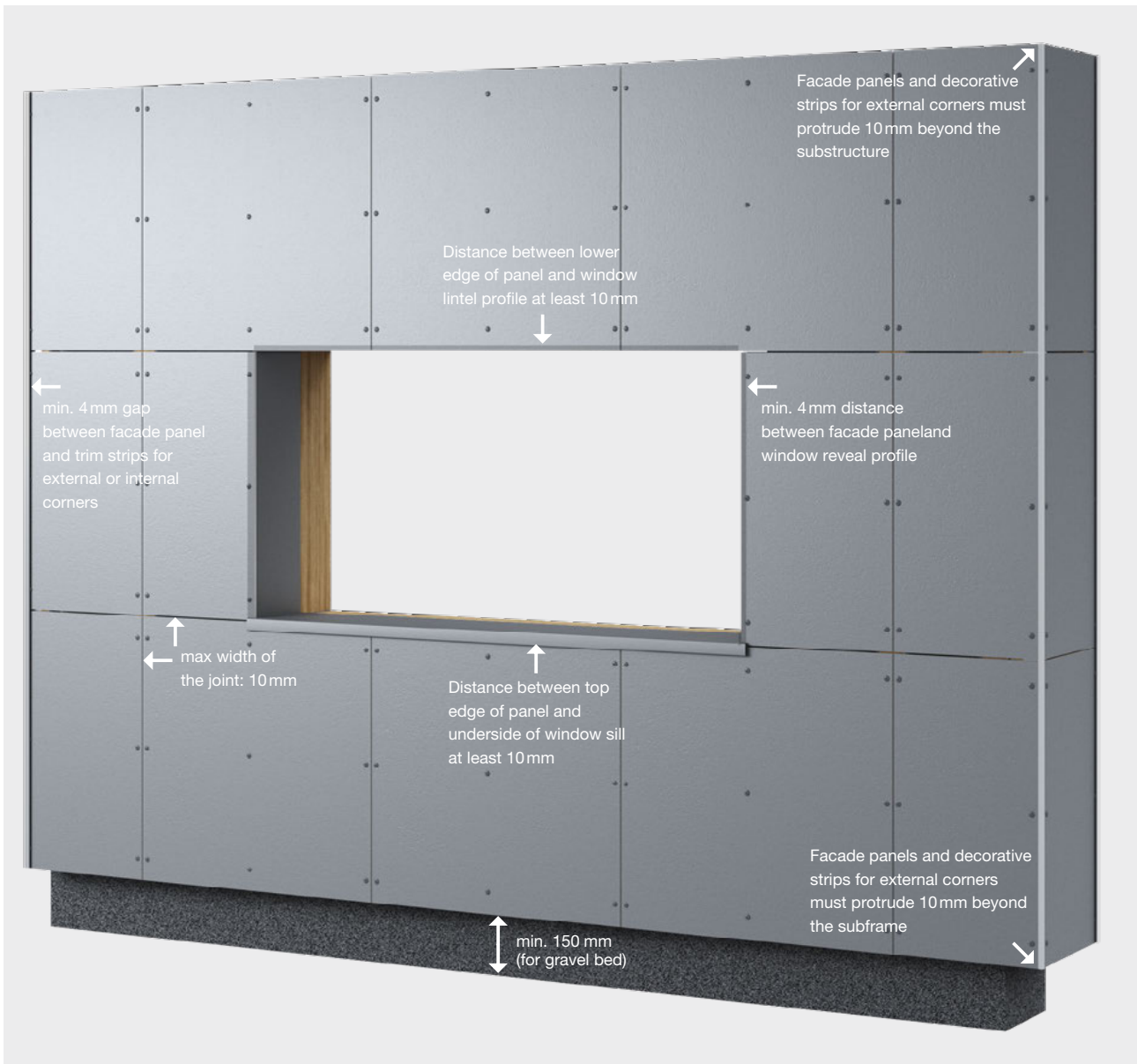

The facade panel must protrude 10 mm in the window lintel area. If a profile is used for the window lintel area, a gap of 4 mm and not 10 mm must be maintained between the panel and the selected profile.

II. External corner with open joint

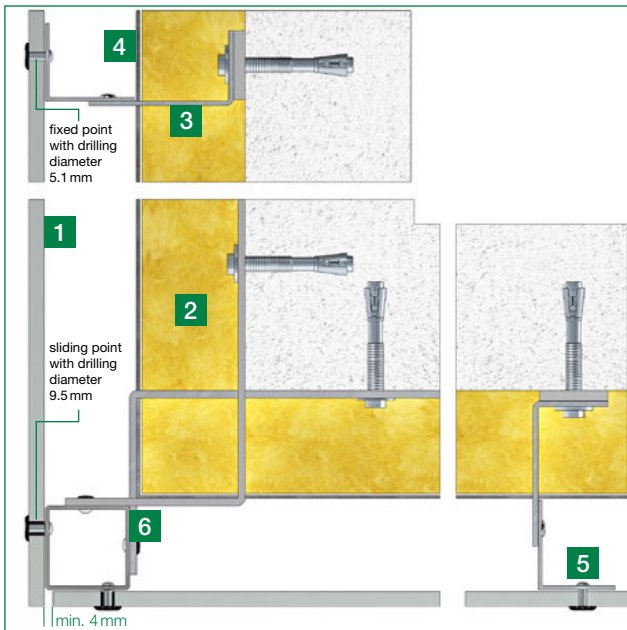

- 1 Hardie® Panel or Hardie® Architectural Panel
- 2 Insulation
- 3 Aluminum wall bracket
- 4 Vertical aluminum support profile (material thickness min. 1.8 mm minimum width for panel joint 100 mm)
- 5 Hardie™ Panel rivet (for aluminum substructure)
- 6 Special support profile for corner area with square tube

For the outside corner solution with an open joint, a joint width of min. 4 mm must be maintained.

III. External corner with Hardie™ Panel MetalTrim™

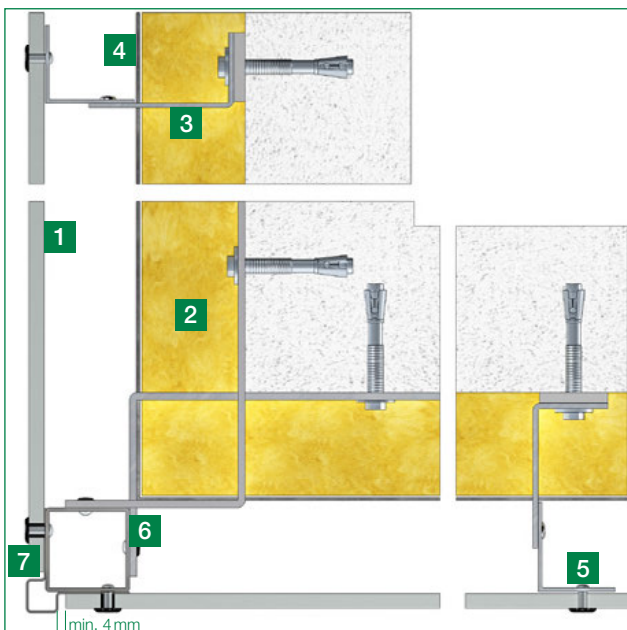

- 1 Hardie® Panel or Hardie® Architectural Panel
- 2 Insulation
- 3 Aluminum wall bracket
- 4 Vertical aluminum support profile (material thickness min. 1.8 mm minimum width for panel joint 100 mm)
- 5 Hardie™ Panel rivet (for aluminum substructure)
- 6 Special support profile for corner area with square tube
- 7 Hardie™ Panel MetalTrim™ strips for external cornerexternal corners

For the outside corner solution with Hardie™ Panel MetalTrim™ trim for outside corners, a joint width of min. 4 mm must be maintained between the outer edge of the facade panel and the profile.

IV. Inside corner with open joint

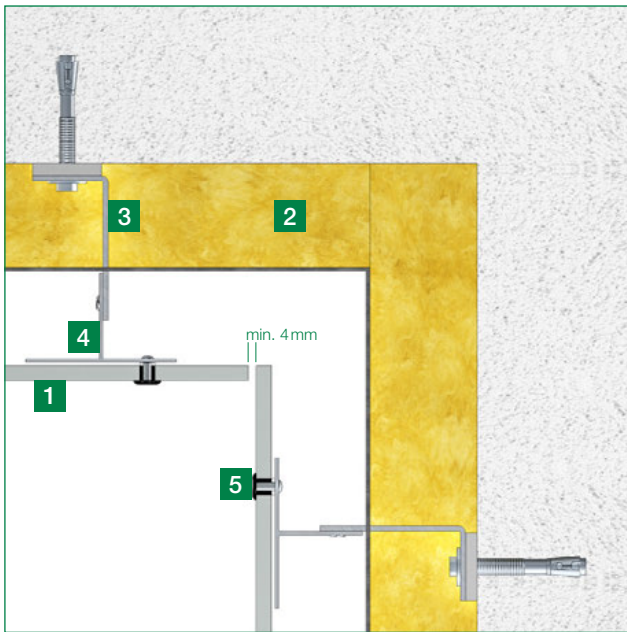

- 1 Hardie® Panel or Hardie® Architectural Panel
- 2 Insulation
- 3 Aluminum wall bracket
- 4 Vertical aluminum support profile (material thickness min. 1.8 mm minimum width for panel joint 100 mm)
- 5 Hardie™ Panel rivet (for aluminum substructure)

For the inside corner solution with open joint, a joint width of min. 4 mm must be maintained.

V. Inside Corner with Hardie™ Panel MetalTrim™

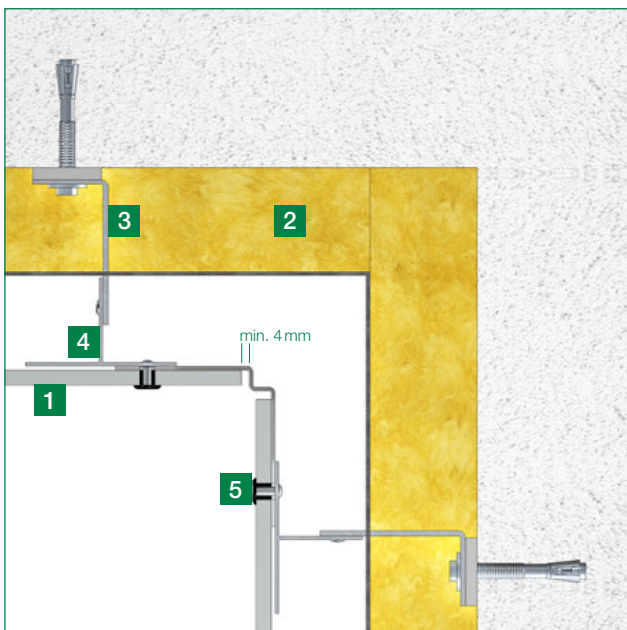

- 1 Hardie® Panel or Hardie® Architectural Panel
- 2 Insulation
- 3 Aluminum wall bracket
- 4 Vertical aluminum support profile (material thickness min. 1.8 mm minimum width for panel joint 100 mm)
- 5 Hardie™ Panel rivet (for aluminum substructure)

For the inside corner solution with Hardie™ Panel MetalTrim™ trim for inside corners, a joint width of min. 4 mm must be maintained between the outer edge of the facade panel and the profile.

VI. Base section

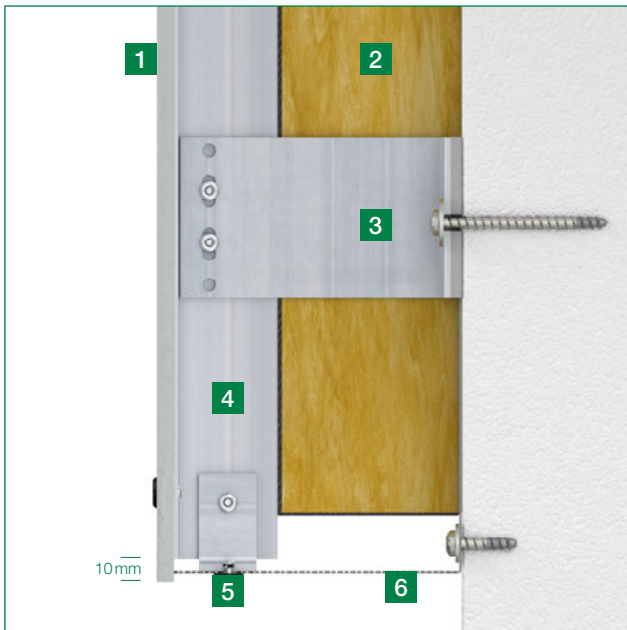

- 1 Hardie® Panel or Hardie® Architectural Panel
- 2 Insulation
- 3 Aluminum wall bracket
- 4 Vertical aluminum support profile (material thickness min. 1.8 mm minimum width for panel joint 100 mm)
- 5 Hardie™ Panel rivet (for aluminum substructure)
- 6 Ventilation profile

Ensure that the cladding panel overlaps the subframes by 10 mm to allow water to drip off the cladding. Ventilation profiles must be installed to prevent small rodents from entering.

VII. Fascia

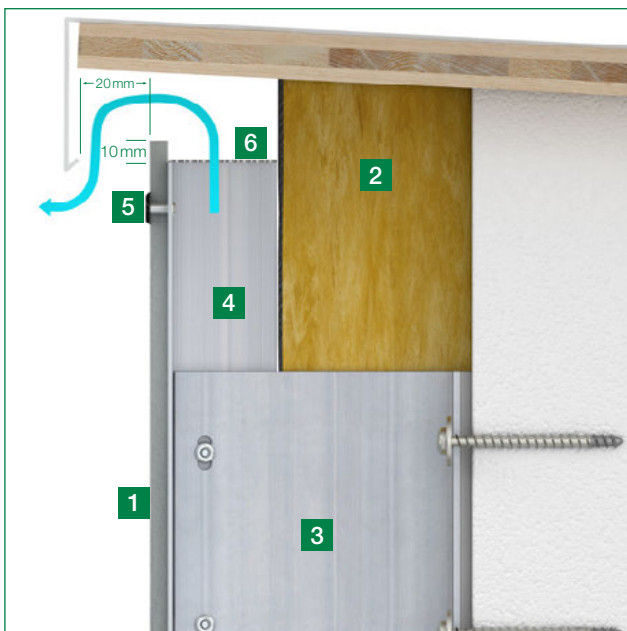

- 1 Hardie® Panel or Hardie® Architectural Panel
- 2 Insulation
- 3 Aluminum wall bracket
- 4 Vertical aluminum support profile (material thickness min. 1.8 mm minimum width for panel joint 100 mm)
- 5 Hardie™ Panel rivet (for aluminum substructure)
- 6 Ventilation profile for Hardie® Panel

be used to ensure rear ventilation. A gap of min. 10 mm must be ensured from the upper edge of the facade panel to the lower edge of the parapet formation. We recommend the use of a ventilation grille also in the upper area of the facade. The drip edge of the parapet should be at least 20 mm in front of the facade. The overlap must be min. 50 mm.

It must be ensured that the air can flow freely behind the facade panel. The facade panel must protrude at least 10 mm above the subframes. A ventilation cross-section of min. 50 cm² per running metre must

The flashing must overlap min. 50 mm up to 8 m, min. 80 mm up to 20 m and min. 100 mm from 20 m building height according to the professional rules of the German Roofing Trade.

VIII. Window reveal with open joint

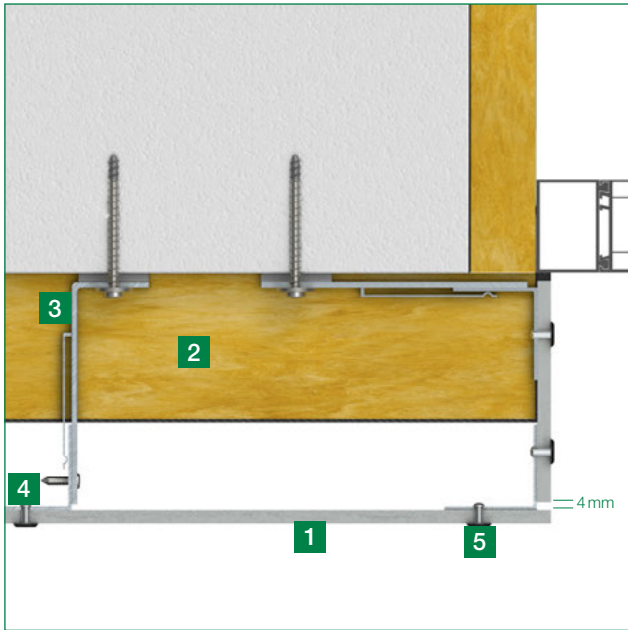

- 1 Hardie® Panel or Hardie® Architectural Panel
- 2 Insulation
- 3 Aluminum wall bracket
- 4 Vertical aluminum support profile (material thickness min. 1.8 mm minimum width for panel joint 100 mm)
- 5 Hardie™ Panel rivet (for aluminum substructure)

It is recommended to fix the reveal strip of Hardie® Panel or Hardie® Architectural Panel to the window frame with a U-profile.

IX. Window reveal with Hardie™ Panel MetalTrim™

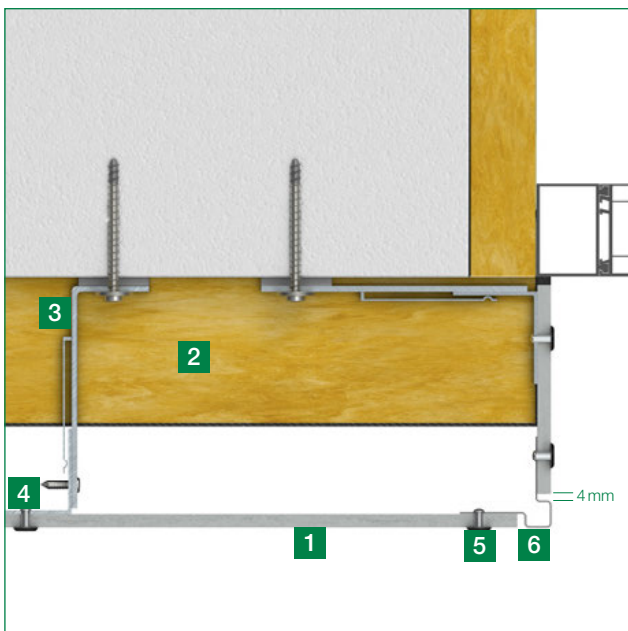

- 1 Hardie® Panel or Hardie® Architectural Panel
- 2 Insulation
- 3 Aluminum wall bracket
- 4 Vertical aluminum support profile (material thickness min. 1.8 mm minimum width for panel joint 100 mm)
- 5 Hardie™ Panel rivet (for aluminum substructure)
- 6 Hardie™ Panel MetalTrim™ trim strips for external corners

When forming the window reveal with Hardie™ Panel MetalTrim™ trim for external corners, a joint width of min. 4 mm must be maintained between the outer edge of the facade panel and the profile.

X. Window sill

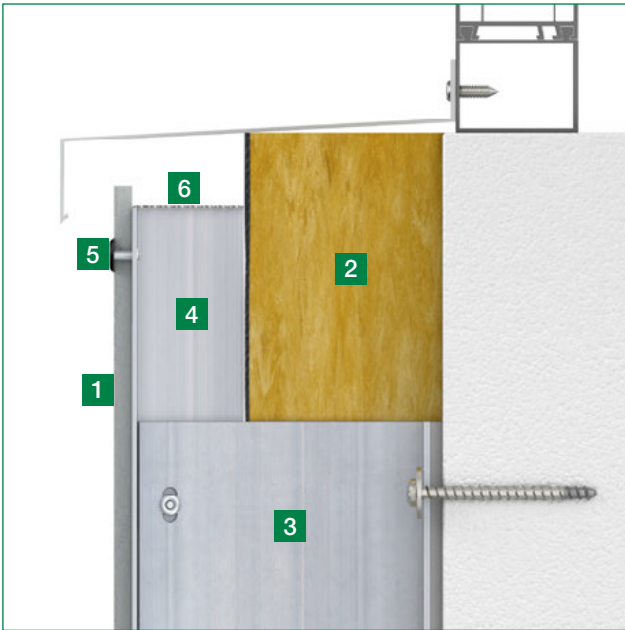

Hardie® Panel and Hardie® Architectural Panel must not be used as a window sill!

- 1 Hardie® Panel or Hardie® Architectural Panel
- 2 Insulation
- 3 Aluminum wall bracket
- 4 Vertical aluminum support profile (material thickness min. 1.8mm minimum width for panel joint 100mm)
- 5 Hardie™ Panel rivet (for aluminum substructure)
- 6 Ventilation profile for Hardie® Panel

The facade cladding must protrude 10mm above the subframes at the top. To avoid soiling, we recommend that the windowsill protrudes at least 30mm above the facade.

There should be at least a gap of 10mm or 50cm² per metre between the upper facade panel and the windowsill for sufficient ventilation.

XI. Window lintel

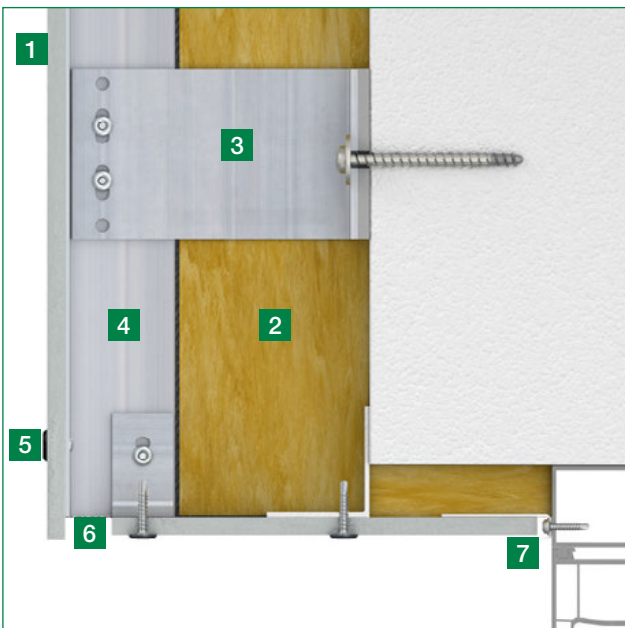

The cladding panels can be fixed with the Hardie™ Panel screw for timber subframes, as on the window reveals. At the window frame, the panels can be inserted into a U-profile. A ventilation gap of

- 1 Hardie® Panel or Hardie® Architectural Panel
- 2 Insulation
- 3 Aluminum wall bracket
- 4 Vertical aluminum support profile (material thickness min. 1.8mm minimum width for panel joint 100mm)
- 5 Hardie™ Panel rivet (for aluminum substructure)
- 6 Ventilation profile for Hardie® Panel
- 7 Suitable U-profile

min. 20mm must be made at the front edge of the panel to the facade side. Use Hardie ventilation profiles to ensure that no small animals can enter the rear ventilation level.

XII. Window lintel with integrated blinds

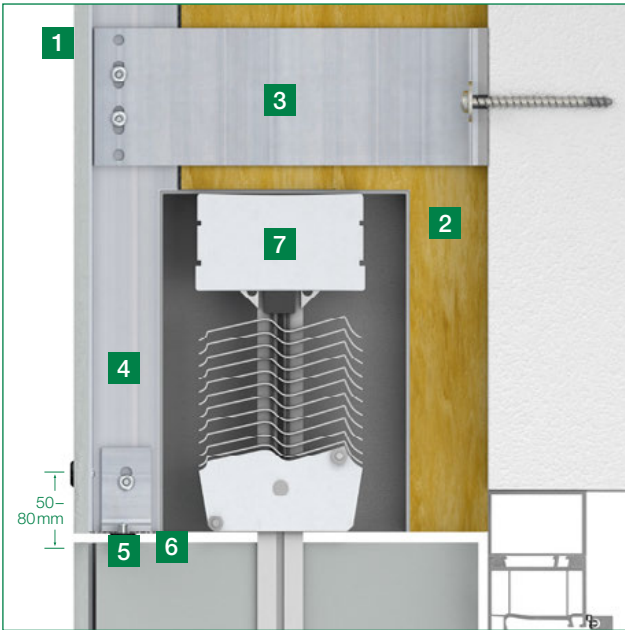

- 1 Hardie® Panel or Hardie® Architectural Panel
- 2 Insulation
- 3 Aluminum wall bracket
- 4 Vertical aluminum support profile (material thickness min. 1.8 mm minimum width for panel joint 100 mm)
- 5 Hardie™ Panel rivet (for aluminum substructure)
- 6 Ventilation profile for Hardie® Panel
- 7 Integrated blinds

Due to the length of the fasteners, care must be taken to ensure that the subframes have a depth of at least 32 mm.

In the case of an integrated louvre, the subframes of the Hardie® Panel and Hardie® Architectural Panel must be routed across the louvre box; it may be necessary to notch the subframes.

The facade panels must not project freely over the blind box or be fastened in the blind box. This will cause damage to the facade panel and insufficient rear ventilation will be guaranteed in this area.

XIII. Window lintel with integrated roller shutter

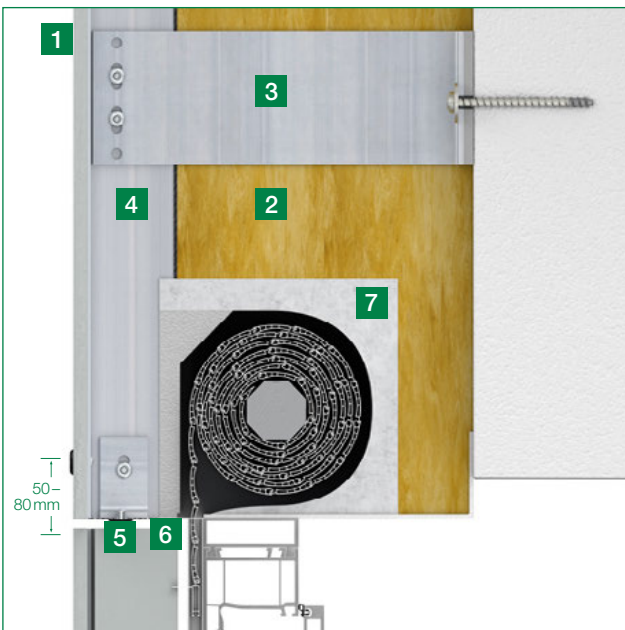

- 1 Hardie® Panel or Hardie® Architectural Panel
- 2 Insulation
- 3 Aluminum wall bracket
- 4 Vertical aluminum support profile (material thickness min. 1.8 mm minimum width for panel joint 100 mm)
- 5 Hardie™ Panel rivet (for aluminum substructure)
- 6 Ventilation profile for Hardie® Panel
- 7 Integrated roller shutter system

As with an integrated blind, the subframes of the facade panels must be routed over the roller shutter

box to ensure sufficient rear ventilation and to prevent damage to the panel.

3.4 Cladding of soffits and fascia

Hardie® Panel and Hardie® Architectural Panel can also be used as cladding for soffits or in overhead applications. z. e.g. from roof overhangs.

This application is usually located regularly, e.g. by the general type approval Z-31.4-193 for Germany.

For the static verification, the dead load of the panels must be increased by a factor of 2.5.

It must be taken into account that the panels may only be fixed to a substructure that is anchored directly to the load-bearing component.

Special loads (e.g. from lamps) must generally be transferred to the load-bearing substrate independently of the facade panels.

When using Hardie® Panel and Hardie® Architectural Panel in overhead applications, a maximum center and fastener spacing of 400 mm is recommended.

When Hardie® Panel and Hardie® Architectural Panel are used as soffits or roof overhangs, the edge distances are basically identical to installation on the ventilated facade. This also applies to the drilling diameter, the joint widths and the distances to adjacent building components.

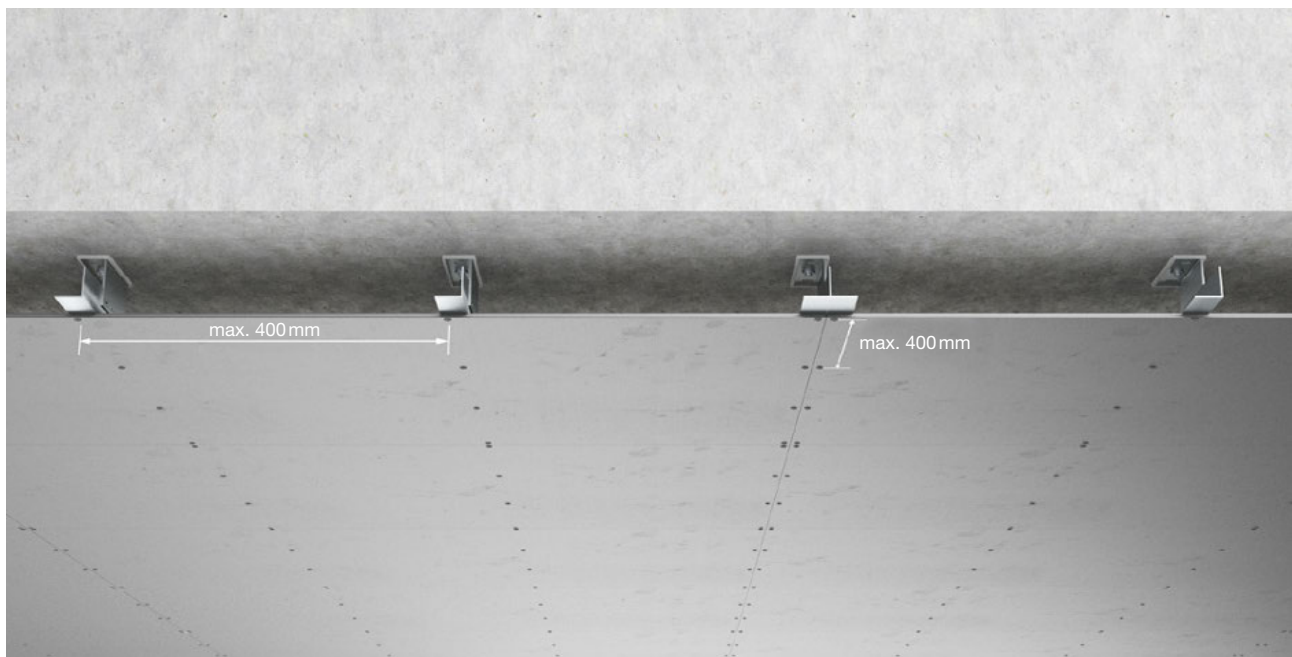

04 Follow-up

4.1 Maintenance and servicing

In general, Hardie® Panel and Hardie® Architectural Panel require little maintenance to maintain their specific properties, stability, and functionality.

Cleaning the facade regularly will maintain a good visual appearance and can be conducted on the required frequency.

4.2 Final and regular cleaning

As a matter of principle, the facade should be cleaned over its entire surface, as partial cleaning can lead to visual impairments.

Before cleaning the entire facade, please test the selected cleaning method on a small area in advance to ensure that the cleaning method does not attack the facade.

The final cleaning of the facade must be carried out from top to bottom always in shadow conditions and must be scheduled before the scaffolding is dismantled.

Light soiling

Light soiling can be cleaned with cold or lukewarm water, if necessary, with a mild solvent-free household cleaner. After cleaning, rinse the facade surface with sufficient cold water.

Dirt stains can be removed with a microfibre cloth or a soft sponge and water.

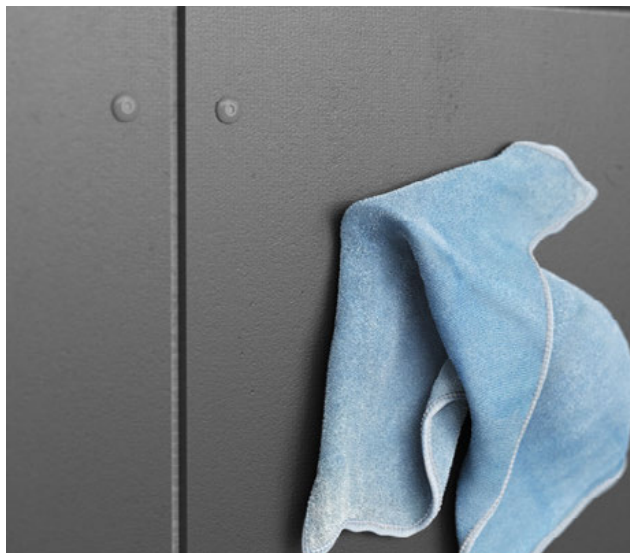

Scratching materials (e.g. steel wool) are not permitted, they leave irreparable scratches on the surface.

Chalk efflorescence, cement splashes, chalk runners

Small chalk stains, cement splashes or chalk runners can be treated with a solution of five percent vinegar cleaner and then rinsed off immediately with plenty of water.

It is possible that slight colour lightening may occur. Please make sure that the vinegar cleaner does not come into contact with metal parts (fasteners, profiles, etc.).

Moss and algae

Moss and algae growth can be removed with common agents available on the market. Examples are hypochlorite that has no long term effect or benzalkonium chloride 2.5 % active that has a long term effect preventing new growth.

After wetting the facade with clean water, the agent is applied according to the supplier's instructions.

Do not leave the agent to dry completely. Rinse with lots of clean water.

Please always check the latest version of the installation guide. The latest version can always be found on the website.

Version Date: 05/2024

© 2024 James Hardie Europe GmbH.
™ and ® denote registered and unregistered trademarks of James Hardie Technology Limited and James Hardie Europe GmbH.

This installation guide/manual sets forth the basic guidelines for Hardie® Panel & Hardie® Architectural Panel installation. It is recommended that installers review national and local building regulation and specific project requirements.

James Hardie Europe GmbH

Bennigsen-Platz 1
40474 Düsseldorf
Germany
www.jameshardie.eu

Contact Information:

Phone: +49 211 54236-200
E-mail: export-jheu@jameshardie.com

har-400-00016/05.24/m

